

## Multi-Voltage Processor Power Supply

### Data Sheet

#### 1 Overview

##### 1.1 Features

- High efficiency regulator system
- Wide input voltage range, up to 60V
- Stand-by mode with low current consumption
- Suitable for standard 12V, 24V and 42V PowerNets
- Step down converter as pre-regulator:  
5.5V / 1.5A
- Step down slope control for lowest EME
- Switching loss minimization
- Three high current linear post-regulators with selectable output voltages:  
5V / 800mA  
3.3V or 2.6V / 500mA  
5V or 3.3V / 350mA
- Six independent voltage trackers (followers):  
5V / 17mA each
- Stand-by regulator with 1mA current capability
- Three independent undervoltage detection circuits (e.g. reset, early warning) for each linear post-regulator
- Power on reset functionality
- Window watchdog triggered by SPI
- Tracker control and diagnosis by SPI
- All outputs protected against short-circuit
- Power-DSO-36 package



| Type       | Ordering Code | Package     |
|------------|---------------|-------------|
| TLE 6361 G | Q 67007-A9466 | P-DSO-36-12 |

■ SMD = Surface Mounted Device

## 1.2 Short functional description

The **TLE 6361 G** is a multi voltage power supply system especially designed for automotive applications using a standard 12V or 24V battery as well as the new 42V powernet. The device is intended to supply 32 bit micro-controller systems which require different supply voltage rails such as 5V, 3.3V and 2.6V. The regulators for external sensors are also provided.

The **TLE 6361 G** cascades a Buck converter block with a linear regulator and tracker block on a single chip to achieve lowest power dissipation thus being able to power the application even at very high ambient temperatures.

The step-down converter delivers a pre-regulated voltage of 5.5V with a minimum current capability of 1.5A.

Supplied by this step down converter three low drop linear post-regulators offer 5V, 3.3V, or 2.6V of output voltages depending on the configuration of the device with current capabilities of 800mA, 500mA and 350mA.

In addition the inputs of six voltage trackers are connected to the 5.5V bus voltage. Their outputs follow the main 5V linear regulator (Q\_LDO1) with high accuracy and are able to drive a current of 17mA each. The trackers can be turned on and off individually by a 16 bit serial peripheral interface (SPI). Through this interface also the status information of each tracker (i.e. short circuit) can be read out.

To monitor the output voltage levels of each of the linear regulators three independent undervoltage detection circuits are available which can be used to implement the reset or an early warning function. The supervision of the  $\mu\text{C}$  is managed by the SPI-triggered window watchdog.

For energy saving reasons while the motor is turned off, the **TLE 6361 G** offers a stand-by mode, where the quiescent current does not exceed 30 $\mu\text{A}$  typically. In this stand-by mode just the stand-by regulator remains active.

The **TLE 6361 G** is based on Infineon Power technology SPT™ which allows bipolar, CMOS and Power DMOS circuitry to be integrated on the same monolithic circuitry.

### 1.3 Pin configuration

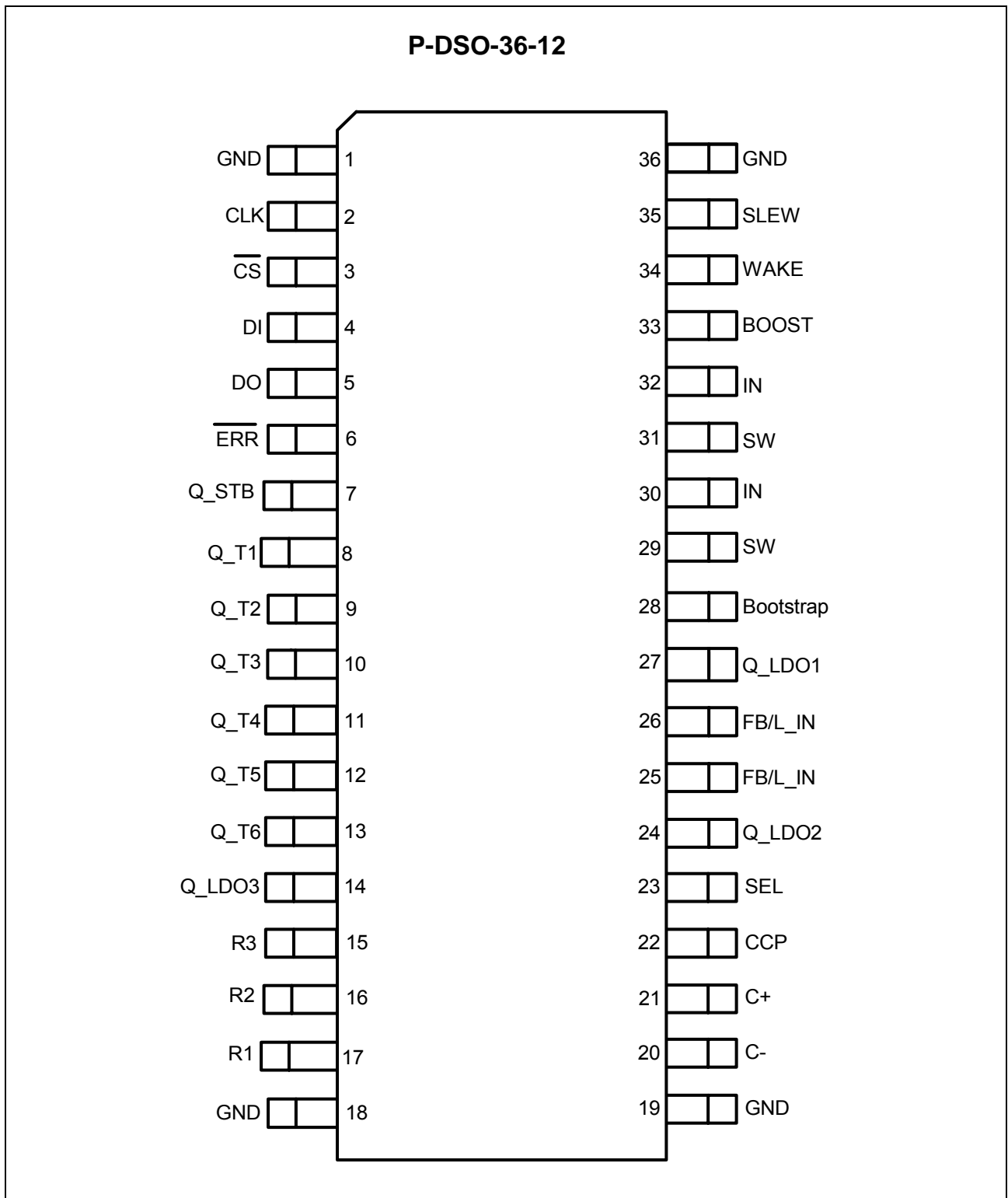

**Figure 1 Pin Configuration (Top View),  
bottom heatslug and GND corner pins are connected**

**1.4 Pin definitions and functions**

| Pin No.    | Symbol                  | Function   |
|------------|-------------------------|--|
| 1,18,19,36 | GND                     | <b>Ground</b> ; to reduce thermal resistance place cooling areas on PCB close to this pins. Those pins are connected internally to the heatslug at the bottom.   |
| 2          | CLK                     | <b>SPI Interface Clock input</b> ; clocks the shiftregister; CLK has an internal active pull down and requires CMOS logic level inputs;see also chapter SPI  |
| 3          | $\overline{\text{CS}}$  | <b>SPI Interface chip select input</b> ; $\overline{\text{CS}}$ is an active low input; serial communication is enabled by pulling the $\overline{\text{CS}}$ terminal low; $\overline{\text{CS}}$ input should only be switched when CLK is low; $\overline{\text{CS}}$ has an internal active pull up and requires CMOS logic level inputs ;see also chapter SPI |
| 4          | DI                      | <b>SPI Interface Data input</b> ; receives serial data from the control device; serial data transmitted to DI is a 16 bit control word with the Least Significant Bit (LSB) being transferred first; the input has an active pull down and requires CMOS logic level inputs; DI will accept data on the falling edge of CLK-signal; see also chapter SPI           |
| 5          | DO                      | <b>SPI Interface Data output</b> ; this tristate output transfers diagnosis data to the controlling device; the output will remain 3-stated unless the device is selected by a low on Chip-Select $\overline{\text{CS}}$ ; see also the chapter SPI  |
| 6          | $\overline{\text{ERR}}$ | <b>Error output</b> ; push-pull output. Monitors failures in parallel to the SPI diagnosis word, reset via SPI. $\overline{\text{ERR}}$ is a latched output.   |
| 7          | Q_STB                   | <b>Standby Regulator Output</b> ; the output is active even when the buck regulator and all other circuitry is in off mode   |
| 8          | Q_T1                    | Voltage <b>Tracker Output T1</b> tracked to Q_LDO1; bypass with a 1 $\mu$ F ceramic capacitor for stability. It is switched on and off by SPI command. Keep open, if not needed.   |
| 9          | Q_T2                    | Voltage <b>Tracker Output T2</b> tracked to Q_LDO1; bypass with a 1 $\mu$ F ceramic capacitor for stability. It is switched on and off by SPI command. Keep open, if not needed.   |
| 10         | Q_T3                    | Voltage <b>Tracker Output T3</b> tracked to Q_LDO1; bypass with a 1 $\mu$ F ceramic capacitor for stability. It is switched on and off by SPI command. Keep open, if not needed.   |

**1.4 Pin definitions and functions (cont'd)**

| Pin No. | Symbol  | Function  |
|---------|---------|---|
| 11      | Q_T4    | Voltage <b>Tracker Output T4</b> tracked to Q_LDO1; bypass with a 1 $\mu$ F ceramic capacitor for stability. It is switched on and off by SPI command. Keep open, if not needed.  |
| 12      | Q_T5    | Voltage <b>Tracker Output T5</b> tracked to Q_LDO1; bypass with a 1 $\mu$ F ceramic capacitor for stability. It is switched on and off by SPI command. Keep open, if not needed.  |
| 13      | Q_T6    | Voltage <b>Tracker Output T6</b> tracked to Q_LDO1; bypass with a 1 $\mu$ F ceramic capacitor for stability. It is switched on and off by SPI command. Keep open, if not needed.  |
| 14      | Q_LDO3  | Voltage Regulator <b>Output 3; 5V or 3.3V output</b> ; output voltage is selected by pin SEL (see also 3.4.2); For stability a ceramic capacitor of 470nF to GND is sufficient.   |
| 15      | R3      | <b>Reset output 3</b> , undervoltage detection for output Q_LDO3; open collector output; an external pullup resistor of 10k $\Omega$ is required                                  |
| 16      | R2      | <b>Reset output 2</b> , undervoltage detection for output Q_LDO2; open collector output; an external pullup resistor of 10k $\Omega$ is required                                  |
| 17      | R1      | <b>Reset output 1</b> , undervoltage detection for output Q_LDO1 and watchdog failure reset; open collector output ; an external pullup resistor of 10k $\Omega$ is required      |
| 20      | C-      | <b>Charge pump capacitor connection</b> ; Add the fly-capacitor of 100nF between C+ and C-  |
| 21      | C+      | <b>Charge pump capacitor connection</b> ; Add the fly-capacitor of 100nF between C+ and C-  |
| 22      | CCP     | <b>Charge Pump Storage Capacitor Output</b> ; Add the storage capacitor of 220nF between pin CCP and GND.   |
| 23      | SEL     | <b>Select Pin</b> for output voltage adjust of Q_LDO2 and Q_LDO3 (see also 2.2.2)   |
| 24      | Q_LDO2  | Voltage Regulator <b>Output 2; 3.3V or 2.6V output</b> ; output voltage is selected by pin SEL (see also 3.4.2); For stability a ceramic capacitor of 470nF to GND is sufficient. |
| 25, 26  | FB/L_IN | <b>Feedback and Linear Regulator Input</b> ; input connection for the Buck converter output   |

**1.4 Pin definitions and functions (cont'd)**

| Pin No. | Symbol    | Function   |
|---------|-----------|--|
| 27      | Q_LDO1    | Voltage Regulator <b>Output 1; 5V output</b> ; acts as the reference for the voltage trackers. The SPI and window watchdog logic is supplied from this voltage. For stability a ceramic capacitor of 470nF to GND is sufficient.   |
| 28      | Bootstrap | <b>Bootstrap Input</b> ; add the bootstrap capacitor between pin SW and pin Bootstrap, the capacitance value should be not lower than 2% of the Buck converter output capacitance  |
| 29, 31  | SW        | <b>Switch Output</b> ; connect both pins externally through short lines directly to the cathode of the catch diode and the Buck circuit inductance.  |
| 30, 32  | IN        | <b>Supply Voltage Input</b> ; connect both pins externally through short lines to the input filter/the input capacitors.   |
| 33      | BOOST     | <b>Boost Input</b> ; for switching loss minimization connect a diode (cathode directly to boost pin) in series with a 100nF ceramic capacitor to the IN pin and from the anode of the diode to the buck converter output a 22Ω resistor. Recommended for 42V applications, in 12/24V applications connect boost directly to IN |
| 34      | WAKE      | <b>Wake Up Input</b> ; a positive voltage applied to this pin turns on the device  |
| 35      | SLEW      | <b>Slew control Input</b> ; a resistor to GND defines the current slope in the buck switch for reduced EME   |

### 1.5 Basic block diagram

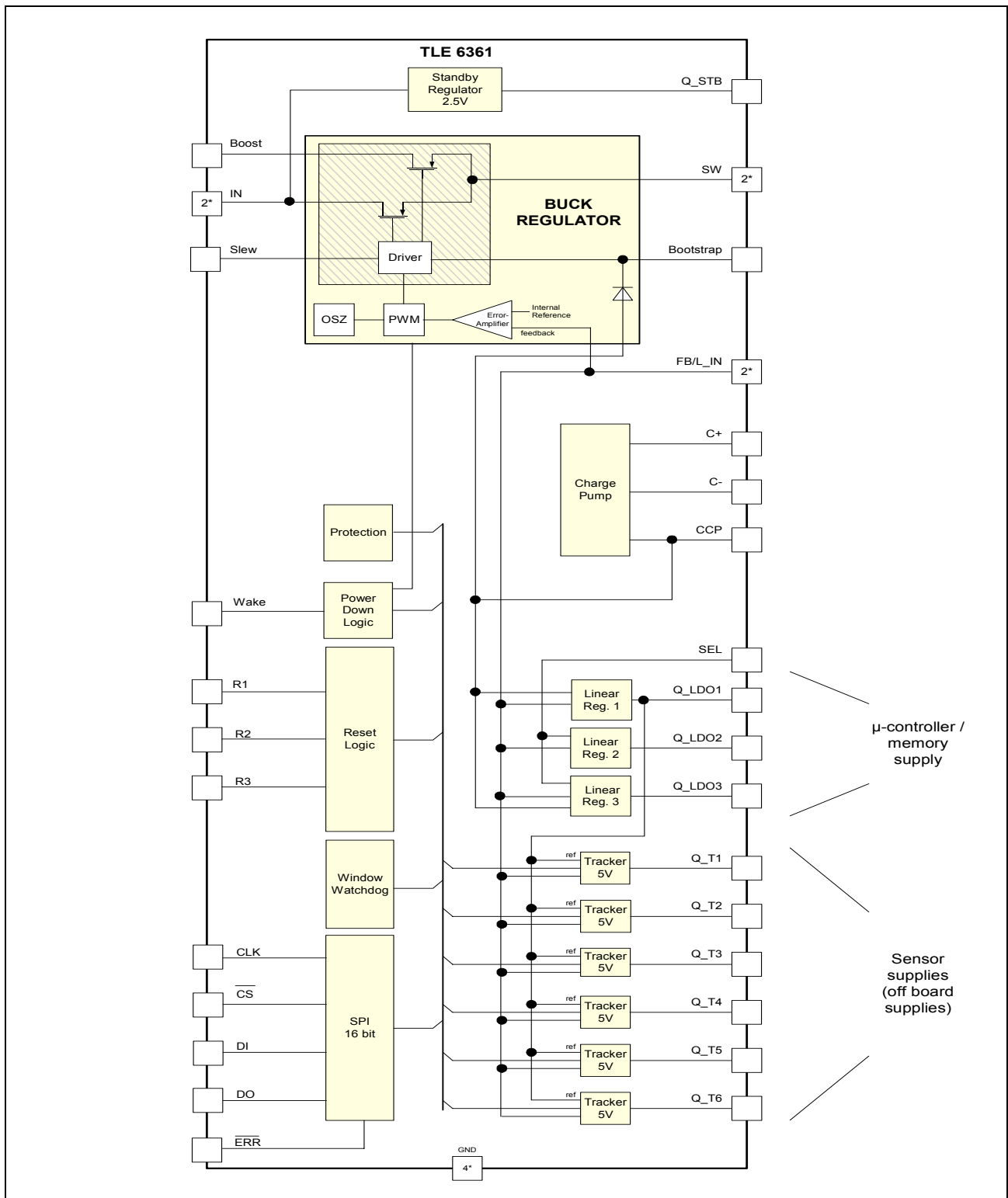

Figure 2 Block Diagram

## 2 Detailed circuit description

In the following major buck regulator blocks, the linear voltage regulators and trackers, the undervoltage reset function, the watchdog and the SPI are described in more detail. For applications information e.g. choice of external components, please refer to section .

### 2.1 Buck Regulator

The diagram below shows the internal implemented circuit of the Buck converter, i. e. the internal DMOS devices, the regulation loop and the other major blocks.

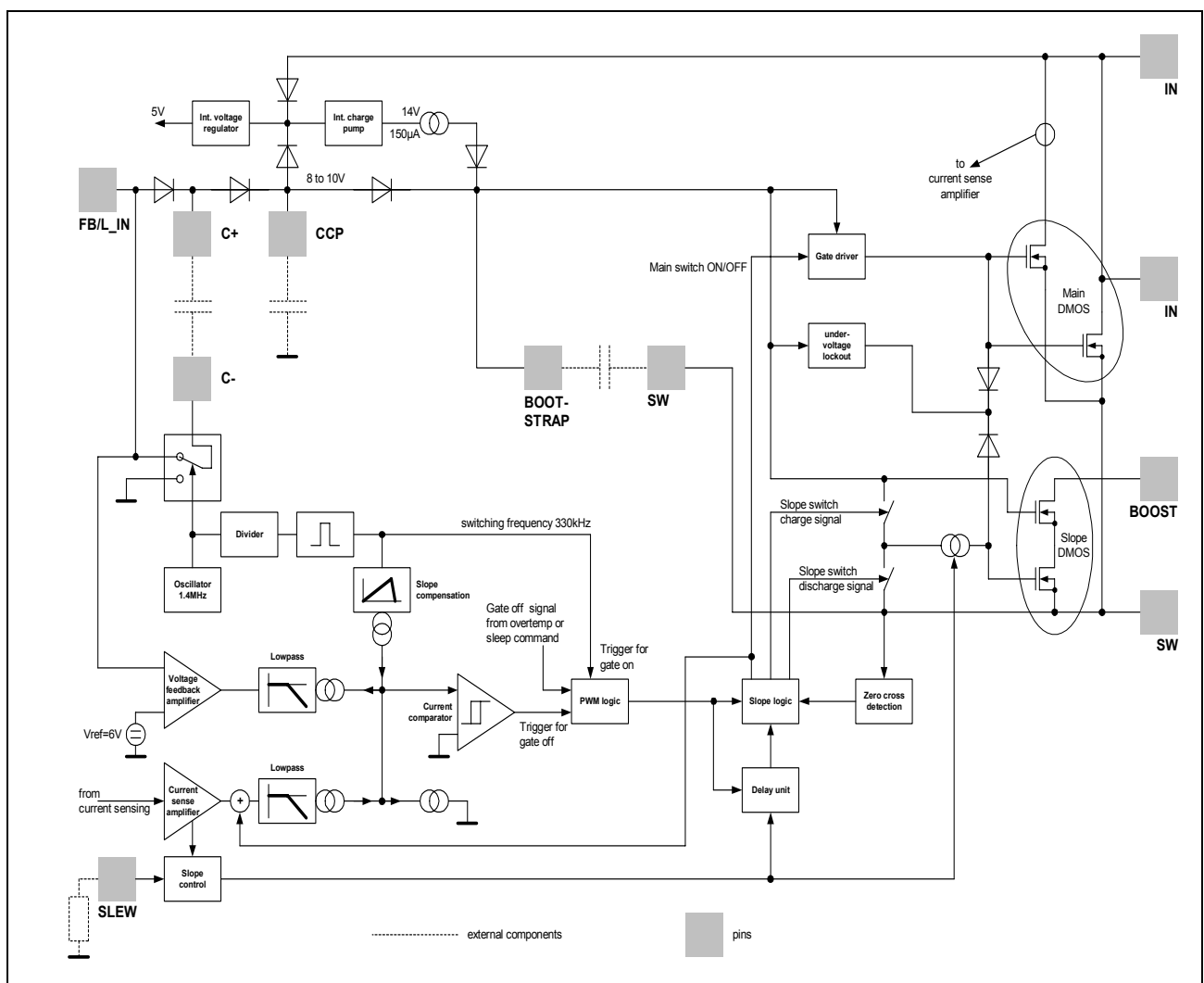

**Figure 3 Detailed Buck regulator diagram**

The 1.5A Buck regulator consists of two internal DMOS power stages including a current mode regulation scheme to avoid external compensation components plus additional blocks for low EME and reduced switching loss. Figure 3 indicates also the principle how



the gate driver supply is managed by the combination of internal charge pump, external charge pump and bootstrap capacitor.

### 2.1.1 Current mode control scheme

The regulation loop is located at the left lower corner in the schematic, there you find the voltage feedback amplifier which gives the actual information of the actual output voltage level and the current sense amplifier for the load current information to form finally the regulation signal. To avoid subharmonic oscillations at duty cycles higher than 50% the slope compensation block is necessary.

The control signal formed out of those three blocks is finally the input of the PWM regulator for the DMOS gate turn off command, which means this signal determines the duty cycle. The gate turn on signal is set by the oscillator periodically every 3 $\mu$ s which leads to a Buck converter switching frequency around 330kHz.

With decreasing input voltage the device changes to the so called pulse skipping mode which means basically that some of the oscillator gate turn off signals are ignored. When the input voltage is still reduced the DMOS is turned on statically (100% duty cycle) and its gate is supplied by the internal charge pump. Below typical 4.5V at the feedback pin the device is turned off. During normal switching operation the gate driver is supplied by the bootstrap capacitor.

### 2.1.2 Start-up procedure

To guarantee a device startup even under full load condition at the linear regulator outputs a special start up procedure is implemented. At first the bootstrap capacitor is charged by the internal charge pump. Afterwards the output capacitor is charged where the driver supply in that case is maintained only by the bootstrap capacitor. Once the output capacitor of the buck converter is charged the external charge pump is activated being able to supply the linear regulators and finally the linear regulators are released to supply the loads.

### 2.1.3 Reduction of electromagnetic emission

In figure 3 it is recognized that two internal DMOS switches are used, a main switch and an auxiliary switch. The second implemented switch is used to adjust the current slope of the switching current. The slope adjustment is done by a controlled charge and discharge of the gate of this DMOS. By choosing the external slew resistor appropriate the current transition time can be adjusted between 20ns and 100ns.

### 2.1.4 Reducing the switching losses

The second purpose of the slope DMOS is to minimise the switching losses. Once being in freewheeling mode of the buck regulator the output voltage level is sufficient to force the load current to flow, the input voltage level is not needed in the first moment. By a feedback network consisting of a resistor and a diode to the boost pin (connection see

section ) the output voltage level is present at the drain of the switch. As soon as the voltage at the SW pin passes zero volts the handover to the main switch occurs and the traditional switching behaviour of the Buck switch can be observed.

## 2.2 Linear Voltage Regulators

The Linear regulators offer voltage rails of 5V, 3.3V and 2.6V which can be determined by a hardware connection (see table at 2.2.2) for proper power up procedure. Being supplied by the output of the Buck pre-regulator the power loss within the three linear regulators is minimized.

All voltage regulators are short circuit protected which means that each regulator provides a maximum current according to its current limit when shorted. Together with the external charge pump the NPN pass elements of the regulators allow low dropout voltage operation. By using this structure the linear regulators work stable even with a minimum of 470nF ceramic capacitors at their output.

Q\_LDO1 has 5V nominal output voltage, Q\_LDO2 has a hardware programmable output voltage of 3.3V or 2.6V and Q\_LDO3 is programmable to 5V or 3.3V (see 2.2.2). All three regulators are on all the time, if one regulator is not needed a base load resistor in parallel to the output capacitance for controlled power down is recommended.

### 2.2.1 Startup Sequence Linear Regulators

When acting as 32 bit  $\mu$ C supply the so-called power sequencing (the dependency of the different voltage rails to each other) is important. Within the TLE 6361 G the following Startup-Sequence is defined (see also figure 4):

$V_{Q\_LDO2} \leq V_{Q\_LDO1}$ ;  $V_{Q\_LDO3} \leq V_{Q\_LDO1}$  with  $V_{Q\_LDO1} = 5V$ ,  $V_{Q\_LDO2} = 2.6V$  and  $V_{Q\_LDO3} = 3.3V$   
and

$V_{Q\_LDO2} \leq V_{Q\_LDO1}$  with  $V_{Q\_LDO1} = 5V$ ,  $V_{Q\_LDO2} = 2.6V/3.3V$  and  $V_{Q\_LDO3} = 5V$

The power sequencing refers to the regulator itself, externally voltages applied at Q\_LDO2 and Q\_LDO3 are not pulled down actively by the device if Q\_LDO1 is lower than those outputs.

That means for the power down sequencing if different output capacitors and different loads at the three outputs of the linear regulators are used the voltages at Q\_LDO2 and Q\_LDO3 might be higher than at Q\_LDO1 due to slower discharging. To avoid this behaviour three Schottky diodes have to be connected between the three outputs of the linear regulators in that way that the cathodes of the diodes are always connected to the higher nominal rail.

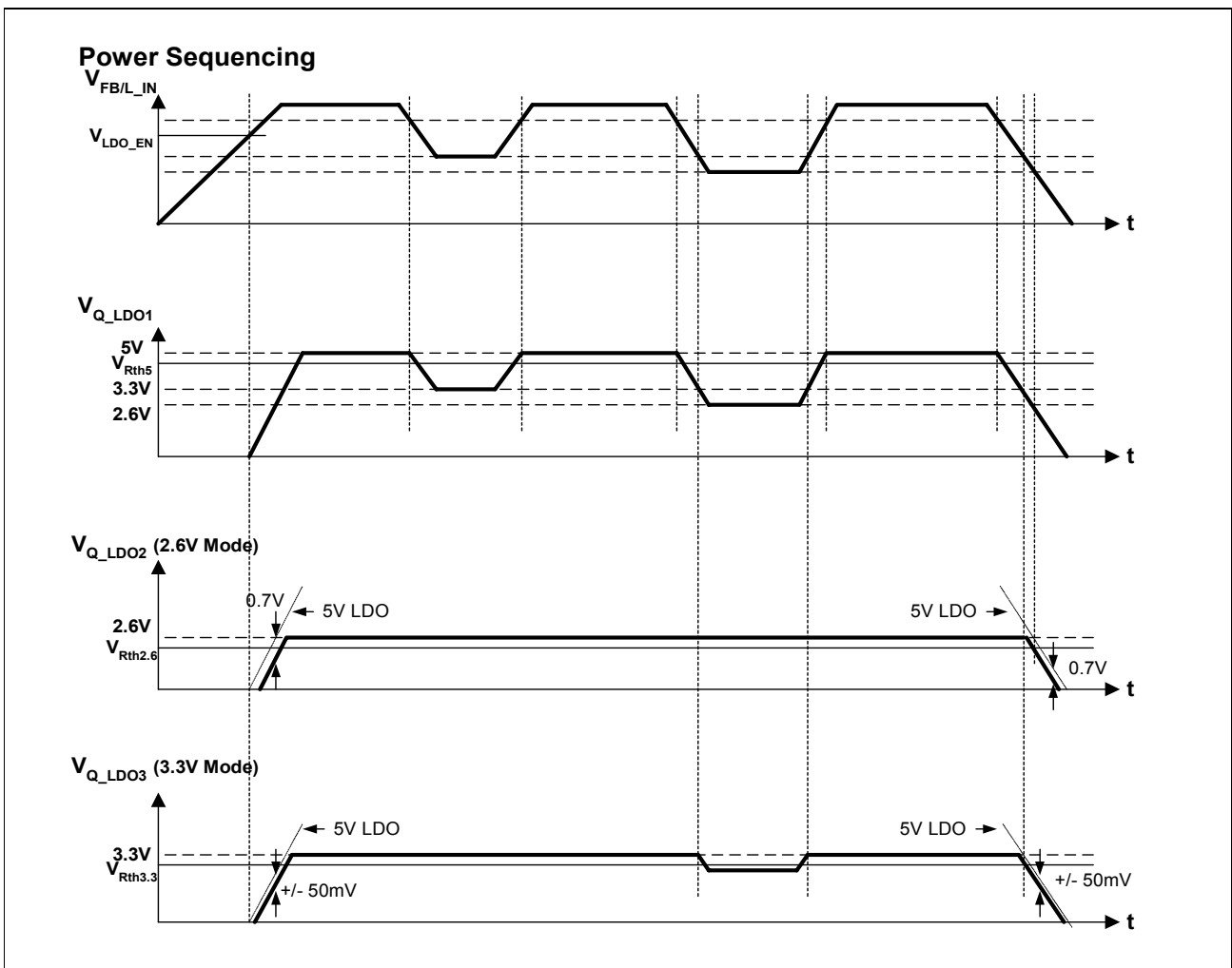

Figure 4 Power-up and -down sequencing of the regulators

### 2.2.2 Q\_LDO2 and Q\_LDO3 output voltage selection\*

To determine the output voltage levels of the three linear regulators, the selection pin (SEL, pin 23) has to be connected according to the matrix given in the table below.

#### Definition of Output voltage Q\_LDO2 and Q\_LDO3

| Select Pin SEL connected to | Q_LDO2 output voltage | Q_LDO3 output voltage |
|-----------------------------|-----------------------|-----------------------|
| GND                         | 3.3 V                 | 5 V                   |
| Q_LDO1                      | 2.6 V                 | 3.3 V                 |
| Q_LDO2                      | 2.6 V                 | 5 V                   |

\* for different output voltages please refer to the multi voltage supply TLE6368

### 2.3 Voltage Trackers

For off board supplies i.e. sensors six voltage trackers Q\_T1 to Q\_T6 with 17mA output current capability each are available. The output voltages match Q\_LDO1 within +5 / -15mV. They can be individually turned on and off by the appropriate SPI command word sent by the microcontroller. A ceramic capacitor with the value of 1 $\mu$ F at the output of each tracker is sufficient for stable operation without oscillation.

The tracker outputs can be connected in parallel to obtain a higher output current capability, no matter if only two or up to all six trackers are tied together. For uniformly distributed current density in each tracker internal balance resistors at each output are foreseen internally. By connecting twice three trackers in parallel two sensors with more than 50mA each can be supplied, all six in parallel give more than 100mA.

The tracker outputs can withstand short circuits to GND or battery in a range from -4 to +40V. A short circuit to GND is detected and indicated individually for each tracker in the SPI status word. Also an open load condition might be recognised and indicated as a failure condition in the SPI status word. A minimum load current of 2mA is required to avoid open load failure indication. In case of connecting several trackers to a common branch balancing currents can prevent proper operation of the failure indication.

### 2.4 Standby Regulator

The standby regulator is an ultra low power 2.5V linear voltage regulator with 1mA output current which is on all the time. It is intended to supply the microcontroller in stop mode and requires then only a minimum of quiescent current (<30 $\mu$ A) to extend the battery lifetime.

### 2.5 Charge Pump

The 1.6 MHz charge pump with the two external capacitors will serve to supply the base of the NPN linear regulators Q\_LDO1 and Q\_LDO3 as well as the gate of the Buck DMOS transistor in 100% duty cycle operation at low battery condition. The charge pump voltage in the range of 8 to 10V can be measured at pin 22 (CCP) but is not intended to be used as a supply for additional circuitry.

### 2.6 Power On Reset

A power on reset is available for each linear voltage regulator output. The reset output lines R1, R2 and R3 are active (low) during start up and turn inactive with a reset delay time after Q\_LDO1, Q\_LDO2 and Q\_LDO3 have reached their reset threshold. The reset outputs are open collector, three pull up resistors of 10k $\Omega$  each have to be connected to the I/O rail (e.g. Q\_LDO1) of the  $\mu$ C. All three reset outputs can be linked in parallel to obtain a wired-OR.

The reset delay time is 64 ms by default and can be set to lower values as 8 ms, 16 ms or 32 ms by SPI command. At each power up of the device when the output voltage at

Q\_LDO1 has decreased below 3.3V (max.) the default settings are valid, means the 64ms delay time. If the voltage on Q\_LDO1 during sleep or power off mode was kept above 3.3V the delay time set by the last SPI command is valid.

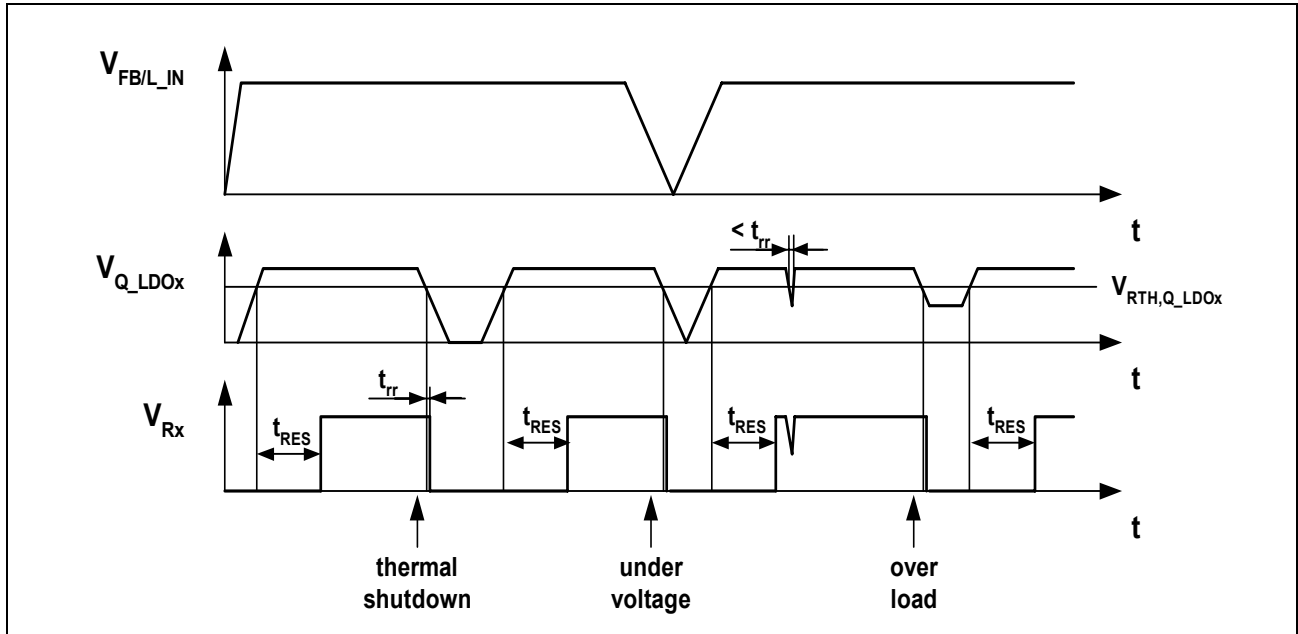

Figure 5 Undervoltage reset timing

## 2.7 RAM good flag

A RAM good flag will be set within the SPI status word when the Q\_LDO1 voltage drops below 2.3V. A second one will be set if Q\_LDO2 drops below typical 1.4V. Both RAM good flags can be read after power up to determine if a cold or warm start needs to be processed. Both RAM good flags will be reset after each SPI cycle.

## 2.8 $\overline{ERR}$ Pin

An hardware error pin indicates any fault conditions on the chip. It should be connected to an interrupt input of the microcontroller. A low signal indicates an error condition. The microcontroller can read the root cause of the error by reading the SPI register.

## 2.9 Window Watchdog

The on board window watchdog for supervision of the  $\mu C$  works in combination with the SPI. The window watchdog logic is triggered when  $\overline{CS}$  is low and Bit WD-Trig in the SPI command word is set to "1". The watchdog trigger is recognized with the low to high transition of the  $\overline{CS}$  signal. To allow reading the SPI at any time without getting a reset due to misinterpretation the WD-Trig bit has to be set to "0" to avoid false trigger conditions. To disable the window watchdog the WD-OFF bits need to be set to "010".

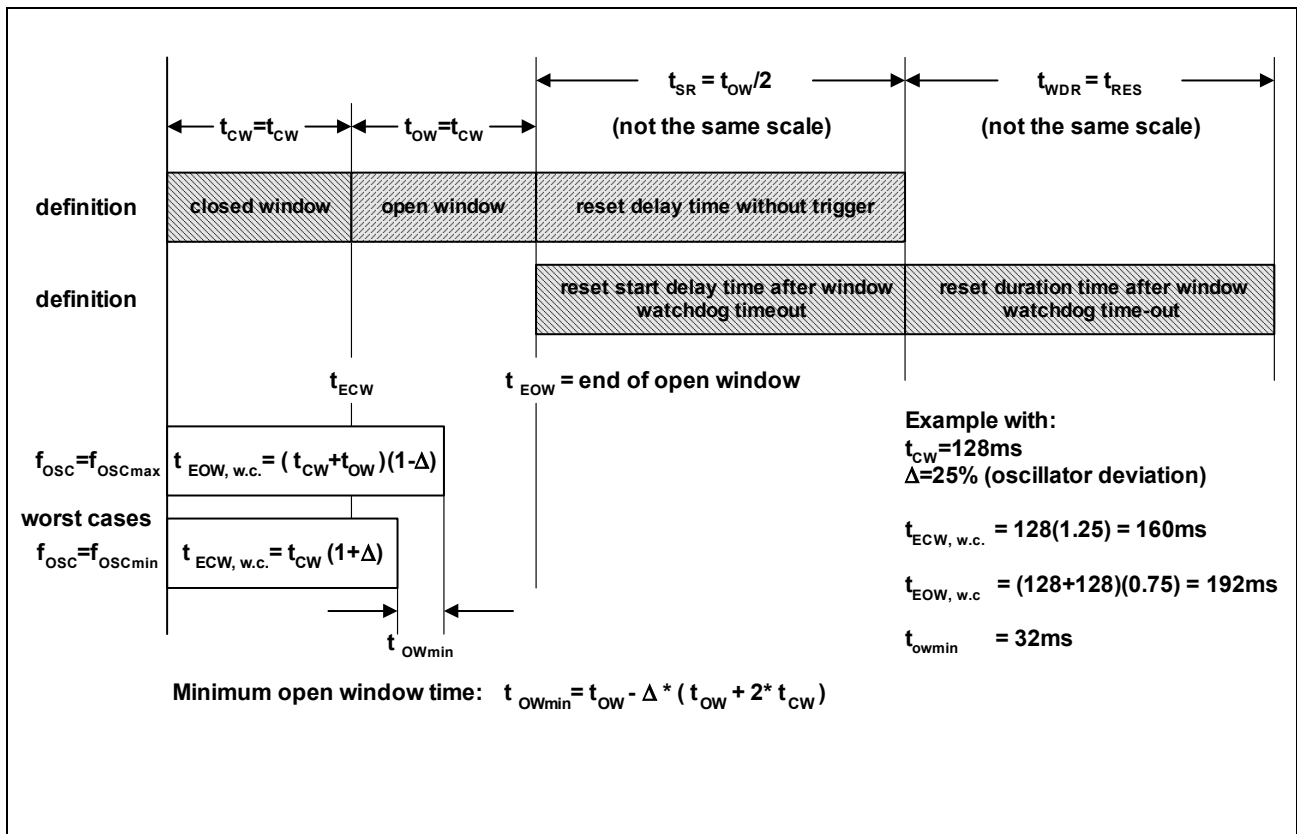
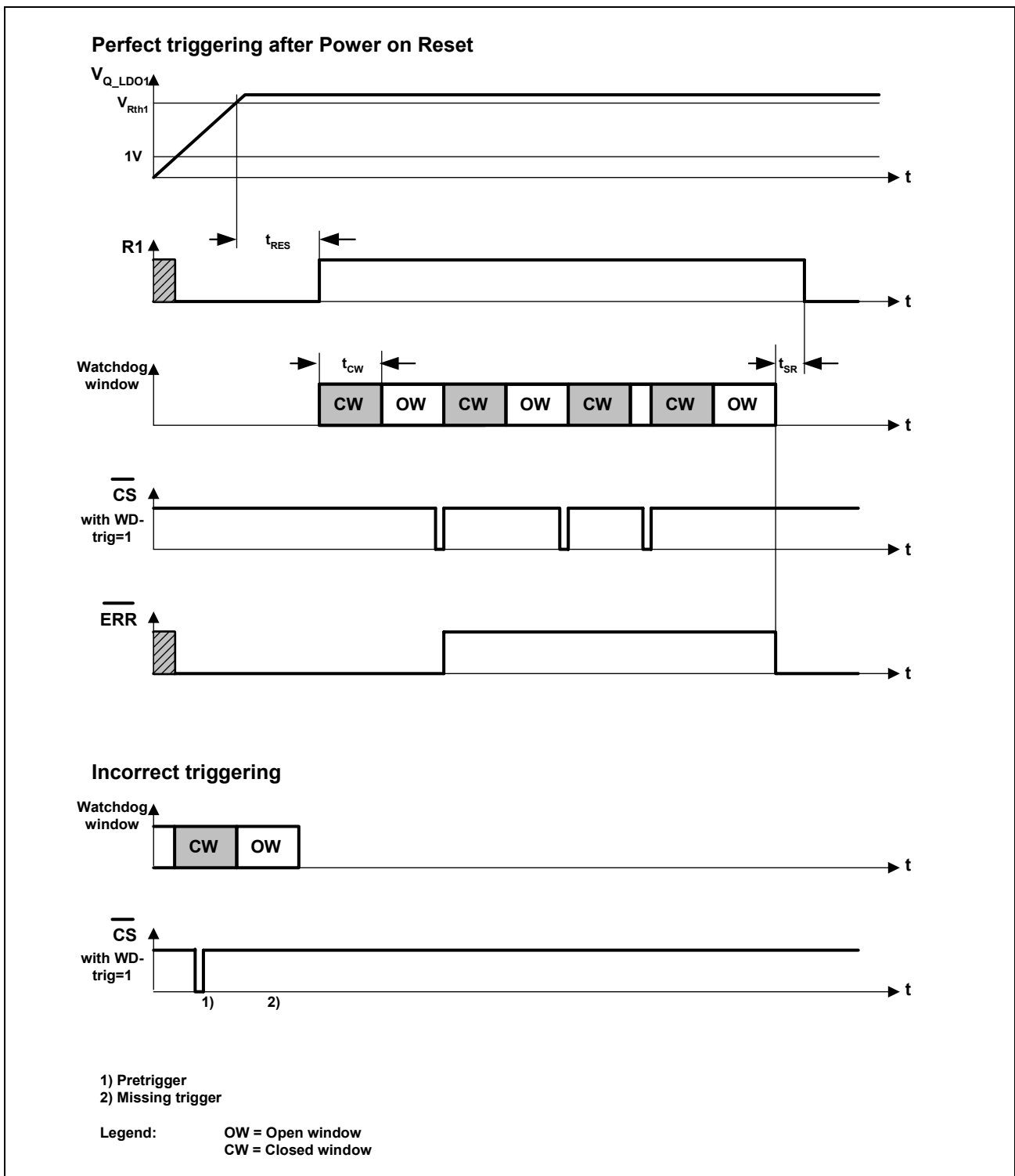

**Figure 6 Window watchdog timing definition**

Figure 6 shows some guidelines for designing the watchdog trigger timing taking the oscillator deviation of different devices into account. Of importance is the maximum (w.c.) of the closed window and the minimum of the open window in which the trigger has to occur.

The length of the OW and CW can be modified by SPI command. If a change of the window length is desired during the Watchdog function is operating please send the SPI command with the new timing with a 'Watchdog trigger Bit' D15=1. In this case the next CW will directly start with the new length.

A minimum time gap of > 1/48 of the actual OW/CW time between a 'Watchdog disable' and 'Watchdog enable' SPI-command should be maintained. This allows the internal Watchdog counters to be resetted. Thus after the enable command the Watchdog will start properly with a full CW of the adjusted length.



**Figure 7 Window watchdog timing**

Figure 7 gives some timing information about the window watchdog. Looking at the upper signals the perfect triggering of the watchdog is shown. When the 5V linear regulator Q\_LDO1 reaches its reset threshold, the reset delay time has to run off before

the closed window (CW) starts. Then three valid watchdog triggers are shown, no effect on the reset line and/or error pin is observed. With the missing watchdog trigger signal the error signal turns low immediately where the reset is asserted after another delay of half the closed window time.

Also shown in the figure are two typical failure modes, one pretrigger and one missing signal. In both cases the error signal will go low immediately the failure is detected with the reset following after the half closed window time.

## 2.10 Overtemperature Protection

At a chip temperature of more than 130° an error and temperature flag is set and can be read through the SPI. The device is switched off if the device reaches the overtemperature threshold of 170°C. The overtemperature shutdown has a hysteresis to avoid thermal pumping.

## 2.11 Power Down Mode

The **TLE 6361 G** is started by a static high signal at the wake input or a high pulse with a minimum of 50µs duration at the Wake input (pin 34). Voltages in the range between the turn on and turn off thresholds for a few 100µs must be avoided!

By SPI command (“Sleep”-bit, D8, equals zero) all voltage regulators including the switching regulator except the standby regulator can be turned off completely only if the wake input is low. In the case the Wake input is permanently connected to battery the device cannot be turned off by SPI command, it will always turn on again.

For stable “on” operation of the device the “Sleep”-bit, D8 has to be set to high at each SPI cycle!

When powering the device again after power down the status of the SPI controlled devices (e.g. trackers, watchdog etc.) depends on the output voltage on Q\_LDO1. Did the voltage at Q\_LDO1 decrease below 3.3V the default status (given in the next section) is set otherwise the last SPI command defines the status.

## 2.12 Serial Peripheral Interface

A standard 16bit SPI is available for control and diagnostics. It is capable to operate in a daisy chain. It can be written or read by a 16 bit SPI interface as well as by an 8 bit SPI interface.

The 16-bit control word (write bit assignment, see figure 8) is read in via the data input DI, synchronous to the clock input CLK supplied by the µC. The diagnosis word appears in the same way synchronously at the data output DO (read bit assignment, see figure 9), so with the first bit shifted on the DI line the first bit appears on the DO line.

The transmission cycle begins when the TLE 6361 G is selected by the “not chip select” input  $\overline{CS}$  (H to L). After the  $\overline{CS}$  input returns from L to H, the word that has been read in at the DI line becomes the new control word. The DO output switches to tristate status at



this point, thereby releasing the DO bus circuit for other uses. For details of the SPI timing please refer to figures 10 to 13.

The SPI will be reset to default values given in the following table “write bit meaning” if the RAM good flag of Q\_LDO1 indicates a cold start (lower output voltage than 3.3V). The reset will be active as long as the power on reset is present so during the reset delay time at power up no SPI commands are acceptable.

The register content of the SPI - including watchdog timings and reset delay timings - is maintained if the RAM good flag of Q\_LDO1 indicates a warm start (i.e. Q\_LDO1 did not decrease below 3.3V).

### 2.12.1 Write mode

The following tables show the bit assignment to the different control functions, how to change settings with the right bit combination and also the default status at power up.

### 2.12.2 Write mode bit assignment

|         |          |              |            |            |            |            |            |            |       |          |         |         |      |      |          |         |
|---------|----------|--------------|------------|------------|------------|------------|------------|------------|-------|----------|---------|---------|------|------|----------|---------|
| BIT     | DO       | D1           | D2         | D3         | D4         | D5         | D6         | D7         | D8    | D9       | D10     | D11     | D12  | D13  | D14      | D15     |
| Name    | WD_OF F1 | NOT assigned | T1-control | T2-control | T6-control | T4-control | T5-control | T6-control | sleep | WD_OF F2 | reset 1 | reset 2 | WD 1 | WD 2 | WD_OF F3 | WD-Trig |
| Default | 1        | X            | 0          | 0          | 0          | 0          | 0          | 0          | 1     | 1        | 0       | 0       | 0    | 0    | 1        | 0       |

**Figure 8 Write Bit assignment**

### Write Bit meaning

| Function   | Bit                              | Combination           | Default |
|--|----------------------------------|-----------------------|---------|
| Not assigned   | D1                               | X                     | X       |
| Tracker 1 to 6 - control:<br>turn on/off the individual trackers | D2<br>D3<br>D4<br>D5<br>D6<br>D7 | 0: OFF<br>1: ON       | 0       |
| Power down:<br>send device to sleep                              | D8                               | 0: SLEEP<br>1: NORMAL | 1       |

**Write Bit meaning**

| Function  | Bit     | Combination                                   | Default |
|---|---------|---|---------|
| Reset timing:<br>Reset delay time $t_{RES}$ valid at warm start   | D10D11  | 00: 64ms<br>10: 32ms<br>01: 16ms<br>11: 8ms   | 00      |
| Window watchdog timing:<br>Open window time $t_{OW}$ and<br>closed window time $t_{CW}$ valid at warm start | D12D13  | 00: 128ms<br>10: 64ms<br>01: 32ms<br>11: 16ms | 00      |
| Window watchdog function:<br>Enable /disable window watchdog  | D0D9D14 | 010: OFF<br>1xx: ON<br>x0x: ON<br>xx1: ON     | 111     |
| Window watchdog trigger:<br>Enable / disable window watchdog trigger  | D15     | 0: not triggered<br>1: triggered              | 1       |

**2.12.3 Read mode**

Below the status information word and the bit assignments for diagnosis are shown.

**2.12.3.1 Read mode bit assignment**

|         |       |           |           |           |           |           |           |           |            |            |           |          |          |          |          |              |
|---------|-------|-----------|-----------|-----------|-----------|-----------|-----------|-----------|------------|------------|-----------|----------|----------|----------|----------|--------------|
| BIT     | D0    | D1        | D2        | D3        | D4        | D5        | D6        | D7        | D8         | D9         | D10       | D11      | D12      | D13      | D14      | D 15         |
| Name    | ERROR | temp_warn | T1-status | T2-status | T3-status | T4-status | T5-status | T6-status | RAM Good 1 | RAM Good 2 | WD Window | R-Error1 | R-Error2 | R-Error3 | WD Error | DC/DC status |
| Default | 0     | 0         | 0         | 0         | 0         | 0         | 0         | 0         | 0          | 0          | 0         | 0        | 0        | 0        | 0        | 1            |

**Figure 9 Read Bit assignment**

Error bit D0:

The error bit indicates fail function and turns high if the temperature prewarning, the watchdog error is active, further if one RAM good indicates a cold start or if a voltage tracker does not settle within 1ms when it is turned on.

In addition to the error indication by software the ERR pin acts as a hardware error flag.

**Read Bit meaning**

| Function  | Type        | Bit                              | Combination  | Default |
|---|-------------|----------------------------------|--|---------|
| Error indication, explanation see below this table      | Latched     | D0                               | 0: normal operation<br>1: fail function  | 0       |
| Overtemperature warning                                 | Not latched | D1                               | 0: normal operation<br>1: prewarning   | 0       |
| Status of Tracker Output Q_T[1:6], only if output is ON | Not latched | D2<br>D3<br>D4<br>D5<br>D6<br>D7 | 1: settled output voltage<br>0: Tracker turned off or shorted output. Also open load may possibly be indicated as 0. <sup>1)</sup> | 0       |
| Indication of cold start/warm start, Q_LDO1             | Latched     | D8                               | 0: cold start<br>1: warm start   | 0       |
| Indication of cold start/warm start, Q_LDO2             | Latched     | D9                               | 0: cold start<br>1: warm start   | 0       |
| Indication for open or closed window                    | Not latched | D10                              | 0: open window<br>1: closed window   | 0       |
| Reset condition at output Q_LDO1                        | Not latched | D11                              | 0: normal operation<br>1: Reset R1   | 0       |
| Reset condition at output Q_LDO2                        | Not latched | D12                              | 0: normal operation<br>1: Reset R2   | 0       |
| Reset condition at output Q_LDO3                        | Not latched | D13                              | 0: normal operation<br>1: Reset R3   | 0       |
| Watchdog Error  | Latched     | D14                              | 0: normal operation<br>1: WD error   | 0       |
| DC/DC converter status                                  | Not latched | D15                              | 0: off<br>1: on  | 1       |

<sup>1)</sup> Min. load current to avoid '0' signal caused by open load is 2mA.

### 2.12.4 SPI Timings

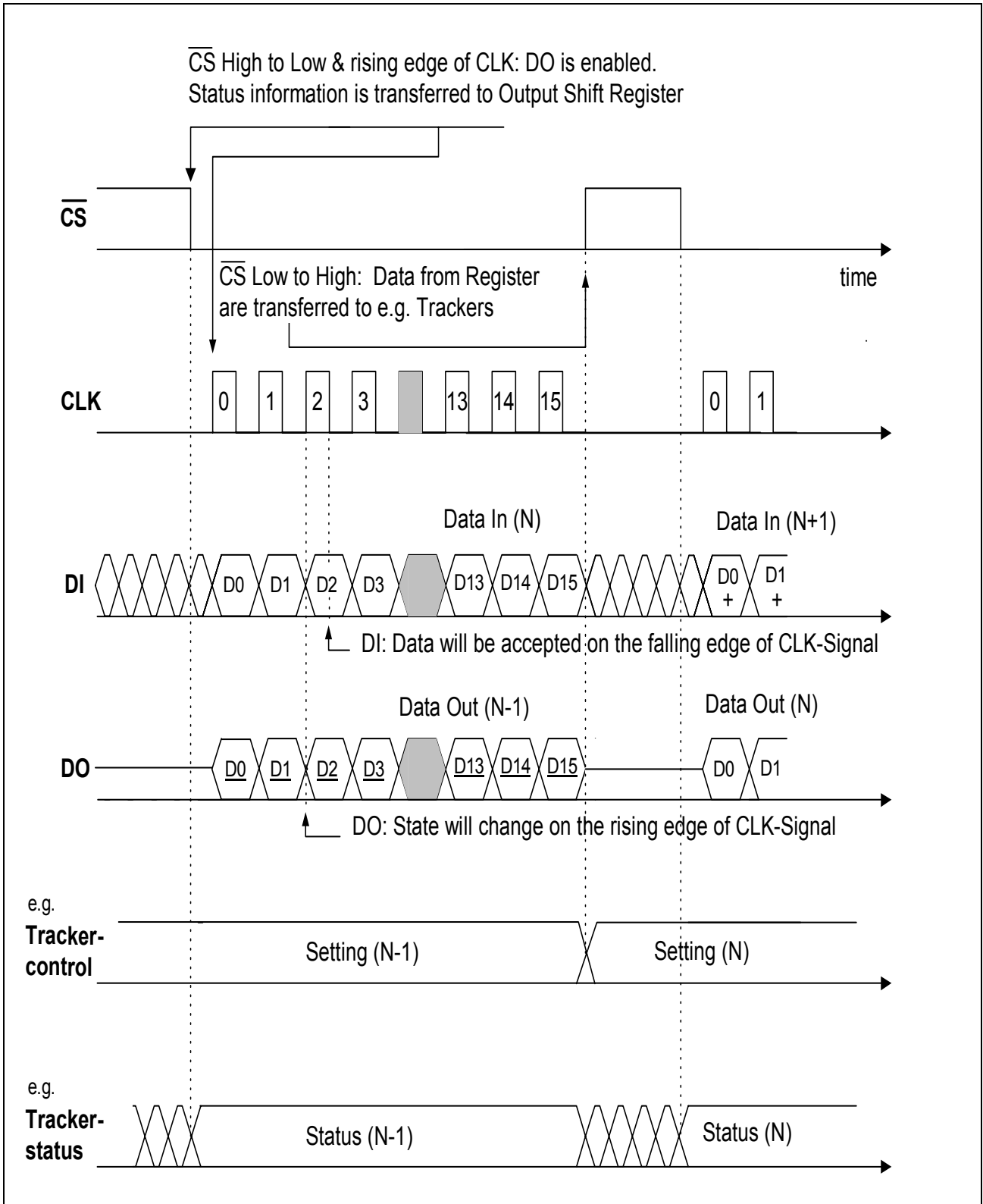

Figure 10 SPI Data Transfer Timing

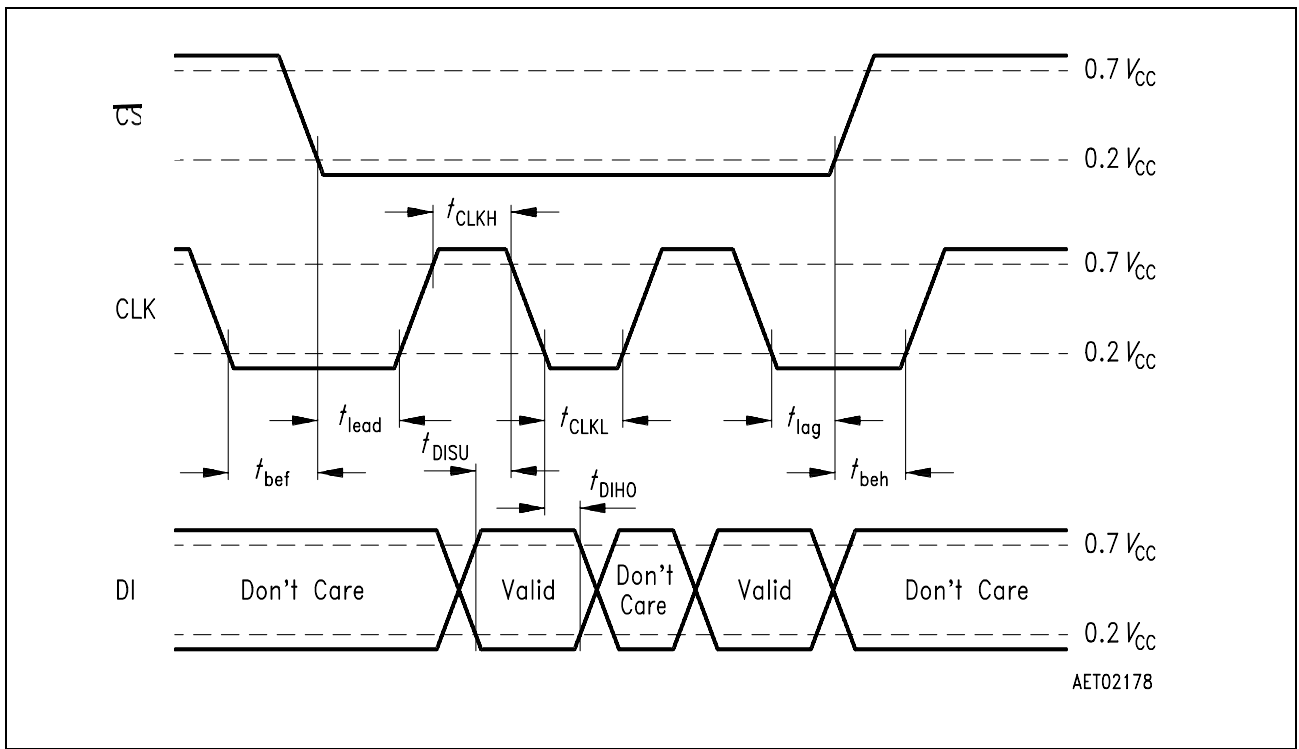

Figure 11 SPI-Input Timing

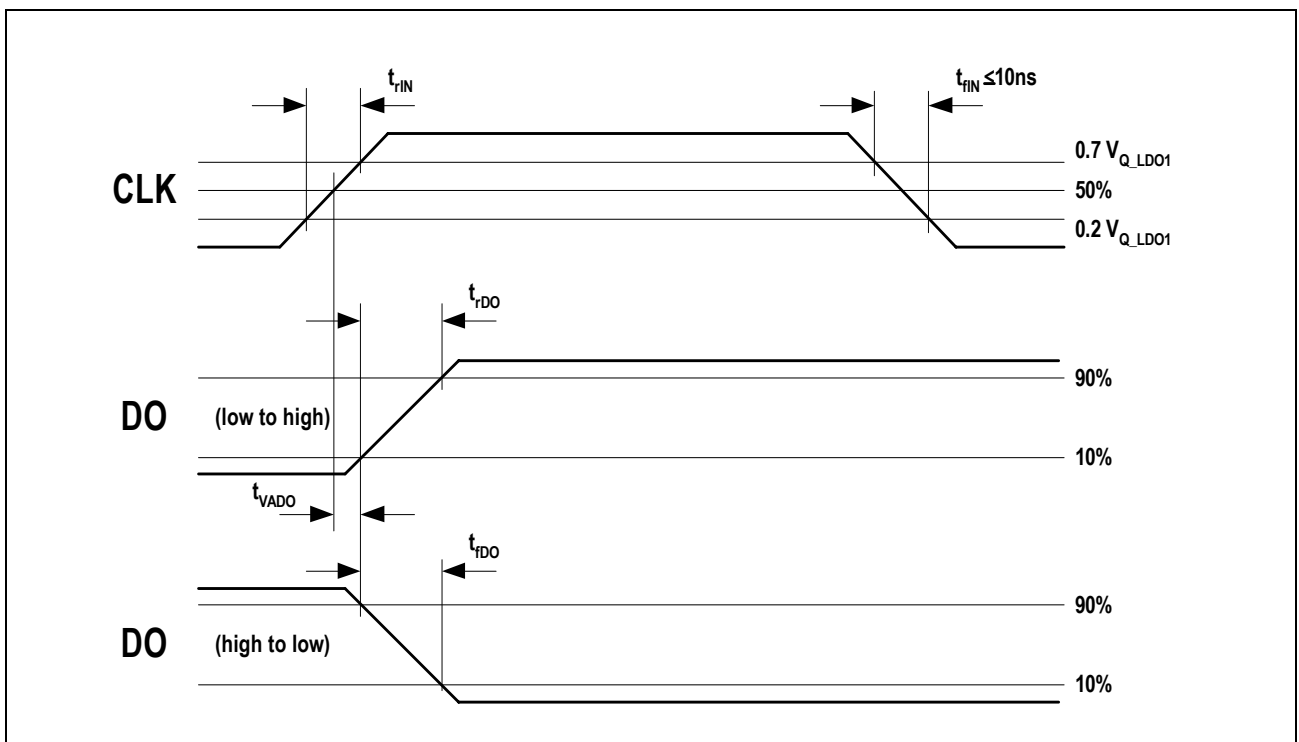

Figure 12 DO Valid Data Delay Time and Valid Time

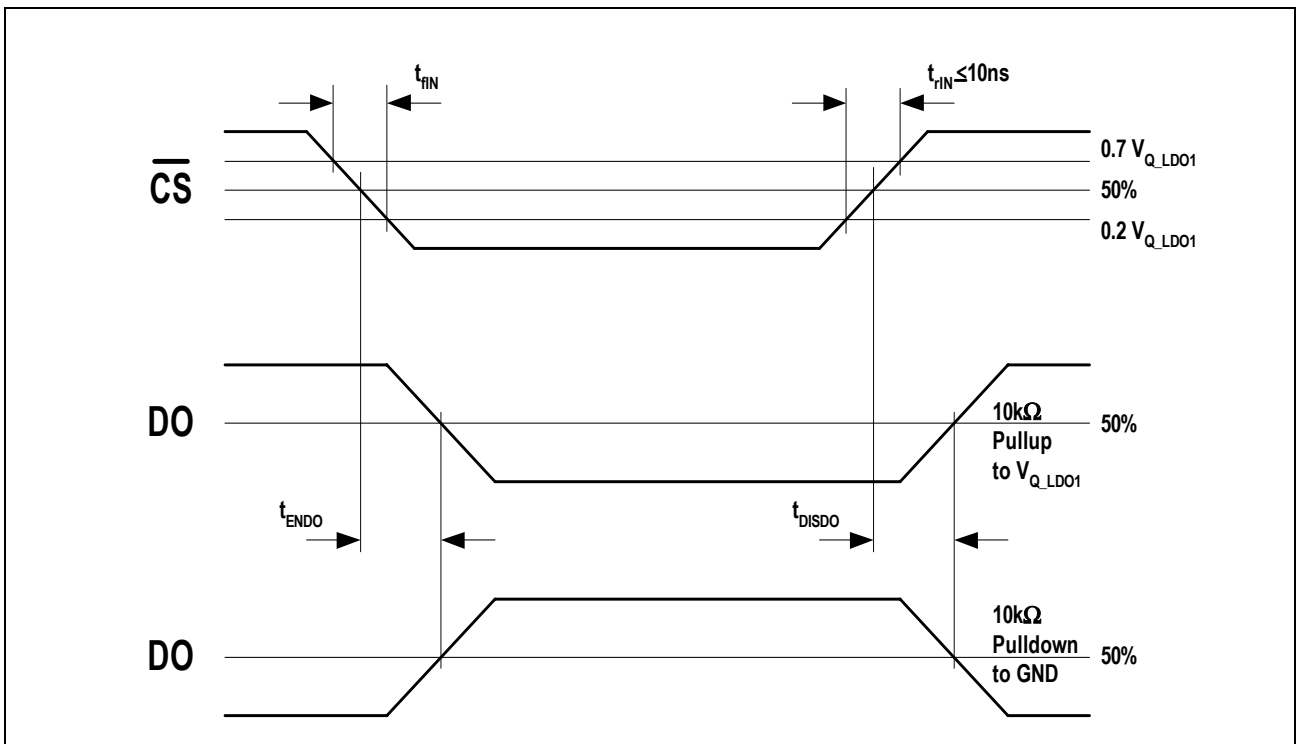

Figure 13 DO Enable and Disable Time

### 3 Characteristics

#### 3.1 Absolute Maximum Ratings

| Item  | Parameter  | Symbol          | Limit Values  |                    | Unit | Test Condition     |
|-------|--|-----------------|---------------|--------------------|------|--------------------|
|       |  |                 | Min.          | Max.               |      |                    |
| 3.1.1 | <b>Supply Voltage Input IN</b>                     |                 |               |                    |      |                    |
|       | Voltage  | $V_{VS}$        | -0.5          | 60                 | V    | –                  |
|       | Current  | $I_{VS}$        | –             | –                  | –    |                    |
| 3.1.2 | <b>Buck-Switch Output SW</b>                       |                 |               |                    |      |                    |
|       | Voltage  | $V_{SW}$        | -2            | $V_S+0.5$          | V    | –                  |
|       | Current  | $I_{SW}$        | –             | –                  | –    |                    |
| 3.1.3 | <b>Feedback and Linear Voltage Regulator Input</b> |                 |               |                    |      |                    |
|       | Voltage  | $V_{FB/L\_IN}$  | -0.5          | 8                  | V    | –                  |
|       | Current  | $I_{FB/L\_IN}$  | –             | –                  | –    |                    |
| 3.1.4 | <b>Bootstrap Connector Bootstrap</b>               |                 |               |                    |      |                    |
|       | Voltage  | $V_{Bootstrap}$ | $V_{SW}-0.5V$ | $V_{SW}+10V$       | V    |                    |
|       | Voltage  | $V_{Bootstrap}$ | -0.5          | 70                 | V    |                    |
|       | Current  | $I_{Bootstrap}$ | –             | –                  | –    | Internally Limited |
| 3.1.5 | <b>Boost Input</b>                                 |                 |               |                    |      |                    |
|       | Voltage  | $V_{Boost}$     | -0.5          | 60                 | V    | –                  |
|       | Current  | $I_{Boost}$     | –             | –                  | –    | Internally Limited |
| 3.1.6 | <b>Slope Control Input Slew</b>                    |                 |               |                    |      |                    |
|       | Voltage  | $V_{Slew}$      | -0.5          | 6                  | V    | –                  |
|       | Current  | $I_{Slew}$      | –             | –                  | –    | Internally Limited |
| 3.1.7 | <b>Charge Pump Capacitor Connector C-</b>          |                 |               |                    |      |                    |
|       | Voltage  | $V_{CL}$        | -0.5          | $V_{FB/L\_IN}+0.5$ | V    |                    |
|       | Current  | $I_{CL}$        | -150          | +150               | mA   |                    |

|               |  |               |      |      |    |                    |
|---------------|--|---------------|------|------|----|--------------------|
| <b>3.1.8</b>  | <b>Charge Pump Capacitor Connector C+</b>      |               |      |      |    |                    |
|               | Voltage  | $V_{CH}$      | -0.5 | 13   | V  |                    |
|               | Current  | $I_{CH}$      | -150 | +150 | mA |                    |
| <b>3.1.9</b>  | <b>Charge Pump Storage Capacitor CCP</b>       |               |      |      |    |                    |
|               | Voltage  | $V_{CCP}$     | -0.5 | 12   | V  |                    |
|               | Current  | $I_{CCP}$     | -150 | –    | mA |                    |
| <b>3.1.10</b> | <b>Standby Voltage Regulator output Q_STB</b>  |               |      |      |    |                    |
|               | Voltage  | $V_{Q\_Stb}$  | -0.5 | 6    | V  | –                  |
|               | Current  | $I_{Q\_Stb}$  | –    | –    | –  | Internally limited |
| <b>3.1.11</b> | <b>Voltage Regulator output voltage Q_LDO1</b> |               |      |      |    |                    |
|               | Voltage  | $V_{Q\_LDO1}$ | -0.5 | 6    | V  | –                  |
|               | Current  | $I_{Q\_LDO1}$ | –    | –    | –  | Internally limited |
| <b>3.1.12</b> | <b>Voltage Regulator output voltage Q_LDO2</b> |               |      |      |    |                    |
|               | Voltage  | $V_{Q\_LDO2}$ | -0.5 | 6    | V  | –                  |
|               | Current  | $I_{Q\_LDO2}$ | –    | –    | –  | Internally limited |
| <b>3.1.13</b> | <b>Voltage Regulator output voltage Q_LDO3</b> |               |      |      |    |                    |
|               | Voltage  | $V_{Q\_LDO3}$ | -0.5 | 6    | V  | –                  |
|               | Current  | $I_{Q\_LDO3}$ | –    | –    | –  | Internally limited |
| <b>3.1.14</b> | <b>Voltage Tracker output voltage Q_T1</b>     |               |      |      |    |                    |
|               | Voltage  | $V_{Q\_T1}$   | -4   | 40   | V  | –                  |
|               | Current  | $I_{Q\_T1}$   | –    | –    | mA | Internally limited |
| <b>3.1.15</b> | <b>Voltage Tracker output voltage Q_T2</b>     |               |      |      |    |                    |
|               | Voltage  | $V_{Q\_T2}$   | -4   | 40   | V  | –                  |
|               | Current  | $I_{Q\_T2}$   | –    | –    | mA | Internally limited |
| <b>3.1.16</b> | <b>Voltage Tracker output voltage Q_T3</b>     |               |      |      |    |                    |
|               | Voltage  | $V_{Q\_T3}$   | -4   | 40   | V  | –                  |
|               | Current  | $I_{Q\_T3}$   | –    | –    | mA | Internally limited |
| <b>3.1.17</b> | <b>Voltage Tracker output voltage Q_T4</b>     |               |      |      |    |                    |
|               | Voltage  | $V_{Q\_T4}$   | -4   | 40   | V  | –                  |
|               | Current  | $I_{Q\_T4}$   | –    | –    | mA | Internally limited |



|   |         |             |      |    |    |                    |
|---|---------|-------------|------|----|----|--------------------|
| <b>3.1.18 Voltage Tracker output voltage Q_T5</b> |         |             |      |    |    |                    |
|   | Voltage | $V_{Q\_T5}$ | -4   | 40 | V  | –                  |
|   | Current | $I_{Q\_T5}$ | –    | –  | mA | Internally limited |
| <b>3.1.19 Voltage Tracker output voltage Q_T6</b> |         |             |      |    |    |                    |
|   | Voltage | $V_{Q\_T6}$ | -4   | 40 | V  | –                  |
|   | Current | $I_{Q\_T6}$ | –    | –  | mA | Internally limited |
| <b>3.1.20 Select Input SEL</b>                    |         |             |      |    |    |                    |
|   | Voltage | $V_{SEL}$   | -0.5 | 6  | V  | –                  |
|   | Current | $I_{SEL}$   | –    | –  | –  | Internally limited |
| <b>3.1.21 Wake Up Input Wake</b>                  |         |             |      |    |    |                    |
|   | Voltage | $V_{Wake}$  | -0.5 | 60 | V  | –                  |
|   | Current | $I_{Wake}$  | –    | –  | –  |                    |
| <b>3.1.22 Reset Output R1</b>                     |         |             |      |    |    |                    |
|   | Voltage | $V_{R1}$    | -0.5 | 6  | V  | –                  |
|   | Current | $I_{R1}$    | –    | –  | –  |                    |
| <b>3.1.23 Reset Output R2</b>                     |         |             |      |    |    |                    |
|   | Voltage | $V_{R2}$    | -0.5 | 6  | V  | –                  |
|   | Current | $I_{R2}$    | –    | –  | –  |                    |
| <b>3.1.24 Reset Output R3</b>                     |         |             |      |    |    |                    |
|   | Voltage | $V_{R3}$    | -0.5 | 6  | V  | –                  |
|   | Current | $I_{R3}$    | –    | –  | –  |                    |
| <b>3.1.25 SPI Data Input DI</b>                   |         |             |      |    |    |                    |
|   | Voltage | $V_{DI}$    | -0.5 | 6  | V  | –                  |
|   | Current | $I_{DI}$    | –    | –  | –  |                    |
| <b>3.1.26 SPI Data Output DO</b>                  |         |             |      |    |    |                    |
|   | Voltage | $V_{DO}$    | -0.5 | 6  | V  | –                  |
|   | Current | $I_{DO}$    | –    | –  | –  | Internally limited |
| <b>3.1.27 SPI Clock Input CLK</b>                 |         |             |      |    |    |                    |
|   | Voltage | $V_{CLK}$   | -0.5 | 6  | V  | –                  |
|   | Current | $I_{CLK}$   | –    | –  | –  |                    |

|   |                                 |                     |      |     |     |   |
|---|---------------------------------|---------------------|------|-----|-----|---|
| <b>3.1.28 SPI Chip Select Not Input <math>\overline{CS}</math></b>                  |                                 |                     |      |     |     |   |
|   | Voltage                         | $V_{\overline{CS}}$ | -0.5 | 6   | V   | –   |
|   | Current                         | $I_{\overline{CS}}$ | –    | –   | –   |   |
| <b>3.1.29 Error Output Pin</b>  |                                 |                     |      |     |     |   |
|   | Voltage                         | $V_{Error}$         | -0.5 | 6   | V   | –   |
|   | Current                         | $I_{Error}$         | –    | –   | –   | Internally limited                                  |
| <b>3.1.30 Thermal Resistance</b>  |                                 |                     |      |     |     |   |
|   | Junction-ambient                | $R_{thja}$          |      | 37  | K/W | <sup>1)</sup> PCB heat sink area 300mm <sup>2</sup> |
|   | Junction-ambient                | $R_{thja}$          |      | 29  | K/W | <sup>1)</sup> PCB heat sink area 600mm <sup>2</sup> |
|   | Junction-case                   | $R_{thjc}$          | –    | 2   | K/W |   |
| <b>3.1.31 Temperature</b>   |                                 |                     |      |     |     |   |
|   | Junction temperature            | $T_j$               | -40  | 150 | °C  |   |
|   | Junction temperature transient  | $T_{jt}$            |      | 175 | °C  | lifetime=TBD  |
|   | Storage temperature             | $T_{stg}$           | -50  | 150 | °C  |   |
| <b>3.1.32 ESD - Protection (Human Body Model; 1.5k<math>\Omega</math>; C=100pF)</b> |                                 |                     |      |     |     |   |
|   | Electrostatic discharge voltage | $V_{ESD}$           | -1   | 1   | kV  | All pins  |

1) Package mounted on FR4 47x50x1.5mm<sup>3</sup>; 70 $\mu$  Cu, zero airflow

*Note: Maximum ratings are absolute ratings; exceeding any one of these values may cause irreversible damage to the integrated circuit.*

### 3.2 Functional Range

$-40^{\circ}\text{C} < T_j < 150^{\circ}\text{C}$

| Item | Parameter         | Symbol                          | Limit Values |      | Unit             | Condition   |
|------|-------------------|---------------------------------|--------------|------|------------------|---|
|      |                   |                                 | min.         | max. |                  |   |
|      | Supply Voltage    | $V_{\text{IN}}$                 | 5.5          |      | V                | To achieve $V_{\text{IN,min}}$ an initial startup with $V_{\text{IN}} > 8\text{V}$ is required; |
|      | Supply Voltage    | $V_{\text{IN}}$                 |              | 60   | V                |   |
|      | Ripple at FB/L_IN | $V_{\text{FB/L\_IN}}$<br>ripple | 0            | 150  | mV <sub>PP</sub> |   |

*Note: Within the functional range the IC can be operated . The electrical characteristics, however, are not guaranteed over this full functional range*

### 3.3 Recommended Operation Range

 $-40^{\circ}\text{C} < T_j < 150^{\circ}\text{C}$ 

| Item | Parameter   | Symbol          | Limit Values |      |      | Unit             | Condition   |
|------|---|-----------------|--------------|------|------|------------------|---|
|      |   |                 | min.         | typ. | max. |                  |   |
|      | Buck Inductor   | $L_B$           | 18           |      | 100  | $\mu\text{H}$    | <sup>1)</sup>   |
|      | Buck Capacitor  | $C_B$           | 10           |      |      | $\mu\text{F}$    | ESR < 0.15 $\Omega$ , ceramic capacitor (X7R) recommended <sup>1)</sup> |
|      | Bootstrap Capacitor   | $C_{BTP}$       | 2            |      |      | % of $C_B$       |   |
|      | SLEW resistor   | $R_{SLEW}$      | 0            |      | 20   | $\text{k}\Omega$ |   |
|      | Linear regulator capacitors                                 | $C_{Q\_LDO1-3}$ | 470          |      |      | $\text{nF}$      | ceramic capacitor (X7R)   |
|      | Tracker bypass capacitors                                   | $C_{Q\_T1-6}$   | 1            |      |      | $\mu\text{F}$    | ceramic capacitor (X7R)   |
|      | SPI rise and fall timings, $\overline{\text{CS}}$ , DI, CLK | $t_{r,f}$       |              |      | 200  | $\text{ns}$      |   |

<sup>1)</sup>  $C_{B, \text{min}}$  needs a Buck inductance  $L_B=47\mu\text{H}$  to avoid instabilities

### 3.4 Electrical Characteristics

The electrical characteristics involve the spread of values guaranteed within the specified supply voltage and ambient temperature range. Typical values represent the median values at room temperature, which are related to production processes.

$-40 < T_j < 150$  °C;  $V_{IN}=13.5V$  unless otherwise specified

| Item                  | Parameter                                   | Symbol         | Limit Values |      |      | Unit       | Test Conditions                          |
|-----------------------|---|----------------|--------------|------|------|------------|--|
|                       |   |                | min.         | typ. | max. |            |  |
| <b>Buck regulator</b> |   |                |              |      |      |            |  |
| 3.4.1                 | Switching frequency                         | $f_{SW}$       | 280          | 370  | 425  | kHz        |  |
| 3.4.2                 | Current transition time, min., rising edge  | $t_{r\_L\_SW}$ |              | 20   |      | ns         | $R_{SL}=0\Omega$ <sup>1)</sup>           |
| 3.4.3                 | Current transition time, max., rising edge  | $t_{r\_L\_SW}$ |              | 100  |      | ns         | $R_{SL}=20k\Omega$ <sup>1)</sup>         |
| 3.4.4                 | Current transition time, min., falling edge | $t_{f\_L\_SW}$ |              | 20   |      | ns         | $R_{SL}=0\Omega$ <sup>1)</sup>           |
| 3.4.5                 | Current transition time, max., falling edge | $t_{f\_L\_SW}$ |              | 100  |      | ns         | $R_{SL}=20k\Omega$ <sup>1)</sup>         |
| 3.4.6                 | Voltage rise / fall time                    | $t_{f\_V\_SW}$ |              | 25   |      | ns         | <sup>1)</sup>                            |
| 3.4.7                 | Static on resistance                        | $R_{ON}$       |              | 160  |      | m $\Omega$ | $T_j=25^\circ C$<br>in static operation  |
| 3.4.8                 | Static on resistance                        | $R_{ON}$       |              | 280  | 400  | m $\Omega$ | $T_j=150^\circ C$<br>in static operation |
| 3.4.9                 | Current limit                               | $I_{MAX}$      | 1.5          |      | 3.2  | A          | $V_{FB/L\_IN}=5.4V$                      |
| 3.4.10                | Output voltage                              | $V_{OUT}$      | 5.4          |      | 6.3  | V          | $I_{OUT}=0.1A$<br>$V_{IN}=13.5 V$        |
| 3.4.11                | Output voltage                              | $V_{OUT}$      | 5.4          |      | 6.05 | V          | $I_{OUT}=1.5A$<br>$V_{IN}=13.5 V$        |

$-40 < T_j < 150 \text{ }^\circ\text{C}$ ;  $V_{IN}=13.5\text{V}$  unless otherwise specified

| Item                            | Parameter  | Symbol   | Limit Values |      |      | Unit          | Test Conditions  |
|---------------------------------|--|--|--------------|------|------|---------------|--|
|                                 |  |  | min.         | typ. | max. |               |  |
| 3.4.12                          | Bootstrap charging current at start-up                 | $I_{BTSTR}$  | 80           | 160  | 220  | $\mu\text{A}$ |  |
| 3.4.13                          | Bootstrap voltage (internal charge pump)               | $V_{BTSTR}$  | 10           |      | 17   | V             | $V_{FB/L\_IN}=6.5\text{V}$ ,<br>Buck converter off   |
| 3.4.14                          | Bootstrap undervoltage lockout, Buck turn on threshold | $V_{BTSTR, \text{turn on}}$                              | 5            |      | 9    | V             |  |
| 3.4.15                          | Bootstrap undervoltage lockout, hysteresis             | $V_{BTSTR, \text{turn on}} - V_{BTSTR, \text{turn off}}$ |              | 2.5  |      | V             |  |
| 3.4.16                          | Charge pump voltage                                    | $V_{CCP}$  | 7.9          |      | 11.0 | V             | $I_{Q\_LDO1} = 800\text{mA}$ ,<br>$V_{FB/L\_IN}=6.0\text{V}$ ,<br>$C_{FLY}=100\text{nF}$ ,<br>$C_{CCP}=220\text{nF}$ |
| 3.4.17                          | Max. Duty Cycle  | $\text{duty}_{\text{max}}$                               |              | 95   |      | %             | Switching operation  |
| 3.4.18                          | Min. Duty Cycle  | $\text{duty}_{\text{min}}$                               |              |      | 0    | %             | Static-off operation   |
| <b>Voltage Regulator Q_LDO1</b> |  |  |              |      |      |               |  |
| 3.4.19                          | Output voltage   | $V_{Q1}$   | 4.9          |      | 5.1  | V             | $100\text{mA} < I_{Q\_LDO1} < 800\text{mA}$  |
| 3.4.20                          | Output voltage   | $V_{Q1}$   |              | 5.0  |      | V             | $I_{Q\_LDO1} = 800\text{mA}$   |
| 3.4.21                          | Load Regulation  | $\Delta V_{Q\_LDO1}$                                     |              | 40   |      | mV            | $100\text{mA} < I_{Q\_LDO1} < 800\text{mA}$ ;<br>$V_{FB/L\_IN}=5,5\text{V}$  |
| 3.4.22                          | Current limit  | $I_{Q\_LDO1\text{limit}}$                                | 800          | 1050 | 1400 | mA            | $V_{Q\_LDO1}=4\text{V}$  |

$-40 < T_j < 150 \text{ }^\circ\text{C}$ ;  $V_{IN}=13.5\text{V}$  unless otherwise specified

| Item                            | Parameter           | Symbol                    | Limit Values |      |       | Unit | Test Conditions   |
|---------------------------------|---------------------|---------------------------|--------------|------|-------|------|---|
|                                 |                     |                           | min.         | typ. | max.  |      |   |
| 3.4.23                          | Ripple rejection    | PSRR1                     | 26           | 40   |       | dB   | $f=330\text{kHz}$ ; <sup>1)</sup>   |
| 3.4.24                          | Output Capacitor    | $C_{Q\_LDO1}$             | 470          |      |       | nF   | Ceramic type, value for stability   |
| <b>Voltage Regulator Q_LDO2</b> |                     |                           |              |      |       |      |   |
| 3.4.25                          | Output voltage 3.3V | $V_{Q\_LDO2}$             | 3.14         |      | 3.46  | V    | $50\text{mA} < I_{Q\_LDO2} < 400\text{mA}$ ;<br>3.3V mode                               |
| 3.4.26                          | Output voltage 3.3V | $V_{Q\_LDO2}$             |              | 3.32 |       | V    | $I_{Q\_LDO2} = 400\text{mA}$ ;<br>3.3V mode   |
| 3.4.27                          | Output voltage 2.6V | $V_{Q\_LDO2}$             | 2.500        |      | 2.750 | V    | $50\text{mA} < I_{Q\_LDO2} < 400\text{mA}$ ;<br>2.6V mode                               |
| 3.4.28                          | Output voltage 2.6V | $V_{Q\_LDO2}$             |              | 2.62 |       | V    | $I_{Q\_LDO2} = 400\text{mA}$ ;<br>2.6V mode   |
| 3.4.29                          | Load Regulation     | $\Delta V_{Q\_LDO2}$      |              | 50   |       | mV   | $50\text{mA} < I_{Q\_LDO3} < 400\text{mA}$ ;<br>$V_{FB/L\_IN}=5.5\text{V}$<br>3.3V mode |
| 3.4.30                          | Load Regulation     | $\Delta V_{Q\_LDO2}$      |              | 50   |       | mV   | $50\text{mA} < I_{Q\_LDO2} < 400\text{mA}$ ;<br>$V_{FB/L\_IN}=5.5\text{V}$<br>2.6V mode |
| 3.4.31                          | Current limit       | $I_{Q\_LDO2\text{limit}}$ | 500          | 650  | 850   | mA   | $V_{Q\_LDO2} = 2.8\text{V}$ ;<br>3.3V mode  |
| 3.4.32                          | Current limit       | $I_{Q\_LDO2\text{limit}}$ | 500          | 650  | 850   | mA   | $V_{Q\_LDO2} = 2\text{V}$ ;<br>2.6V mode  |
| 3.4.33                          | Ripple rejection    | PSRR2                     | 26           | 40   |       | dB   | $f=330\text{kHz}$ ; <sup>1)</sup>   |
| 3.4.34                          | Output Capacitor    | $C_{Q\_LDO2}$             | 470          |      |       | nF   | Ceramic type, value for stability   |
| <b>Voltage Regulator Q_LDO3</b> |                     |                           |              |      |       |      |   |

$-40 < T_j < 150 \text{ }^\circ\text{C}$ ;  $V_{IN}=13.5\text{V}$  unless otherwise specified

| Item                        | Parameter                        | Symbol                 | Limit Values |      |      | Unit | Test Conditions   |
|-----------------------------|----------------------------------|------------------------|--------------|------|------|------|---|
|                             |                                  |                        | min.         | typ. | max. |      |   |
| 3.4.35                      | Output voltage 5V                | $V_{Q\_LDO3}$          | 4.8          |      | 5.2  | V    | $20\text{mA} < I_{Q\_LDO3} < 300\text{mA}$ ;<br>5V mode                                   |
| 3.4.36                      | Output voltage 5V                | $V_{Q\_LDO3}$          |              | 5.0  |      | V    | $I_{Q\_LDO3} = 300\text{mA}$ ;<br>5V mode   |
| 3.4.37                      | Output voltage 3.3V              | $V_{Q\_LDO3}$          | 3.14         |      | 3.46 | V    | $20\text{mA} < I_{Q\_LDO3} < 300\text{mA}$ ;<br>3.3V mode                                 |
| 3.4.38                      | Output voltage 3.3V              | $V_{Q\_LDO3}$          |              | 3.32 |      | V    | $I_{Q\_LDO3} = 300\text{mA}$ ;<br>3.3V mode   |
| 3.4.39                      | Load Regulation                  | $\Delta V_{Q\_LDO3}$   |              | 100  |      | mV   | $20\text{mA} < I_{Q\_LDO3} < 300\text{mA}$ ;<br>$V_{FB/L\_IN} = 5,5\text{V}$<br>5V mode   |
| 3.4.40                      | Load Regulation                  | $\Delta V_{Q\_LDO3}$   |              | 50   |      | mV   | $20\text{mA} < I_{Q\_LDO3} < 300\text{mA}$ ;<br>$V_{FB/L\_IN} = 5,5\text{V}$<br>3.3V mode |
| 3.4.41                      | Current limit                    | $I_{Q\_LDO3}$<br>limit | 350          | 500  | 600  | mA   | $V_{Q\_LDO3} = 4\text{V}$ ;<br>5V mode  |
| 3.4.42                      | Current limit                    | $I_{Q\_LDO3}$<br>limit | 350          | 500  | 600  | mA   | $V_{Q\_LDO3} = 2.8\text{V}$ ;<br>3.3V mode  |
| 3.4.43                      | Ripple rejection                 | PSRR3                  | 26           | 40   |      | dB   | $f = 330\text{kHz}$ ; <sup>1)</sup>   |
| 3.4.44                      | Output Capacitor                 | $C_{Q\_LDO3}$          | 470          |      |      | nF   | Ceramic type,<br>value for stability  |
| <b>Voltage Tracker Q_T1</b> |                                  |                        |              |      |      |      |   |
| 3.4.45                      | Output voltage tracking accuracy | $\Delta V_{Q\_T1}$     | -15          |      | 5    | mV   | $V_{Q\_T1} - V_{Q\_LDO1}$ ;<br>$1\text{mA} < I_{Q\_T1} < 17\text{mA}$                     |
| 3.4.46                      | Output voltage tracking accuracy | $\Delta V_{Q\_T1}$     |              | -10  |      | mV   | $V_{Q\_T1} - V_{Q\_LDO1}$ ;<br>$I_{Q\_T1} = 17\text{mA}$                                  |



$-40 < T_j < 150 \text{ }^\circ\text{C}$ ;  $V_{IN}=13.5\text{V}$  unless otherwise specified

| Item                        | Parameter                        | Symbol                    | Limit Values |                           |      | Unit          | Test Conditions   |
|-----------------------------|----------------------------------|---------------------------|--------------|---------------------------|------|---------------|---|
|                             |                                  |                           | min.         | typ.                      | max. |               |   |
| 3.4.47                      | Overvoltage threshold            | $V_{OVQ\_T1}$             |              | $V_{Q\_T1, \text{nom}}$   |      | mV            | $I_{Q\_T1} = 0\text{mA}$ ; <sup>1)</sup>                              |
| 3.4.48                      | Undervoltage threshold           | $V_{UVQ\_T1}$             |              | $V_{Q\_T1} - 15\text{mV}$ |      | mV            | <sup>1)</sup>   |
| 3.4.49                      | Current limit                    | $I_{Q\_T1 \text{ limit}}$ | 17           |                           | 30   | mA            | $V_{Q\_T1}=4\text{V}$   |
| 3.4.50                      | Ripple rejection                 | PSRR                      | 26           |                           |      | dB            | $f=330\text{kHz}$ ; <sup>1)</sup>                                     |
| 3.4.51                      | Tracker load capacitor           | $C_{Q\_T1}$               | 1            |                           |      | $\mu\text{F}$ | Ceramic type, minimum for stability                                   |
| <b>Voltage Tracker Q_T2</b> |                                  |                           |              |                           |      |               |   |
| 3.4.52                      | Output voltage tracking accuracy | $\Delta V_{Q\_T2}$        | -15          |                           | 5    | mV            | $V_{Q\_T2} - V_{Q\_LDO1}$ ;<br>$1\text{mA} < I_{Q\_T2} < 17\text{mA}$ |
| 3.4.53                      | Output voltage tracking accuracy | $\Delta V_{Q\_T2}$        |              | -10                       |      | mV            | $V_{Q\_T2} - V_{Q\_LDO2}$ ;<br>$I_{Q\_T2} = 17\text{mA}$              |
| 3.4.54                      | Overvoltage threshold            | $V_{OVQ\_T2}$             |              | $V_{Q\_T2, \text{nom}}$   |      | mV            | $I_{Q\_T2} = 0\text{mA}$ ; <sup>1)</sup>                              |
| 3.4.55                      | Undervoltage threshold           | $V_{UVQ\_T2}$             |              | $V_{Q\_T2} - 15\text{mV}$ |      | mV            | <sup>1)</sup>   |
| 3.4.56                      | Current limit                    | $I_{Q\_T2 \text{ limit}}$ | 17           |                           | 30   | mA            | $V_{Q\_T2}=4\text{V}$   |
| 3.4.57                      | Ripple rejection                 | PSRR                      | 26           |                           |      | dB            | $f=330\text{kHz}$ ; <sup>1)</sup>                                     |
| 3.4.58                      | Tracker load capacitor           | $C_{Q\_T2}$               | 1            |                           |      | $\mu\text{F}$ | Ceramic type, minimum for stability                                   |
| <b>Voltage Tracker Q_T3</b> |                                  |                           |              |                           |      |               |   |

$-40 < T_j < 150 \text{ }^\circ\text{C}$ ;  $V_{IN}=13.5\text{V}$  unless otherwise specified

| Item                        | Parameter                        | Symbol                    | Limit Values |                         |      | Unit          | Test Conditions   |
|-----------------------------|----------------------------------|---------------------------|--------------|-------------------------|------|---------------|---|
|                             |                                  |                           | min.         | typ.                    | max. |               |   |
| 3.4.59                      | Output voltage tracking accuracy | $\Delta V_{Q\_T3}$        | -15          |                         | 5    | mV            | $V_{Q\_T3}-V_{Q\_LDO1}$ ;<br>$1\text{mA} < I_{Q\_T3} < 17\text{mA}$ |
| 3.4.60                      | Output voltage tracking accuracy | $\Delta V_{Q\_T3}$        |              | -10                     |      | mV            | $V_{Q\_T3}-V_{Q\_LDO3}$ ;<br>$I_{Q\_T3} = 17\text{mA}$              |
| 3.4.61                      | Overvoltage threshold            | $V_{OVQ\_T3}$             |              | $V_{Q\_T3, \text{nom}}$ |      | mV            | $I_{Q\_T3} = 0\text{mA}$ ; <sup>1)</sup>                            |
| 3.4.62                      | Undervoltage threshold           | $V_{UVQ\_T3}$             |              | $V_{Q\_T3}-15\text{mV}$ |      | mV            | <sup>1)</sup>   |
| 3.4.63                      | Current limit                    | $I_{Q\_T3 \text{ limit}}$ | 17           |                         | 30   | mA            | $V_{Q\_T3}=4\text{V}$   |
| 3.4.64                      | Ripple rejection                 | PSRR                      | 26           |                         |      | dB            | $f=330\text{kHz}$ ; <sup>1)</sup>                                   |
| 3.4.65                      | Tracker load capacitor           | $C_{Q\_T3}$               | 1            |                         |      | $\mu\text{F}$ | Ceramic type, minimum for stability                                 |
| <b>Voltage Tracker Q_T4</b> |                                  |                           |              |                         |      |               |   |
| 3.4.66                      | Output voltage tracking accuracy | $\Delta V_{Q\_T4}$        | -15          |                         | 5    | mV            | $V_{Q\_T4}-V_{Q\_LDO1}$ ;<br>$1\text{mA} < I_{Q\_T4} < 17\text{mA}$ |
| 3.4.67                      | Output voltage tracking accuracy | $\Delta V_{Q\_T4}$        |              | -10                     |      | mV            | $V_{Q\_T4}-V_{Q\_LDO4}$ ;<br>$I_{Q\_T4} = 17\text{mA}$              |
| 3.4.68                      | Overvoltage threshold            | $V_{OVQ\_T4}$             |              | $V_{Q\_T4, \text{nom}}$ |      | mV            | $I_{Q\_T4} = 0\text{mA}$ ; <sup>1)</sup>                            |
| 3.4.69                      | Undervoltage threshold           | $V_{UVQ\_T4}$             |              | $V_{Q\_T4}-15\text{mV}$ |      | mV            | <sup>1)</sup>   |
| 3.4.70                      | Current limit                    | $I_{Q\_T4 \text{ limit}}$ | 17           |                         | 30   | mA            | $V_{Q\_T4}=4\text{V}$   |
| 3.4.71                      | Ripple rejection                 | PSSR                      | 26           |                         |      | dB            | $f=330\text{kHz}$ ; <sup>1)</sup>                                   |

$-40 < T_j < 150 \text{ }^\circ\text{C}$ ;  $V_{IN}=13.5\text{V}$  unless otherwise specified

| Item                        | Parameter                        | Symbol                    | Limit Values |                         |      | Unit          | Test Conditions   |
|-----------------------------|----------------------------------|---------------------------|--------------|-------------------------|------|---------------|---|
|                             |                                  |                           | min.         | typ.                    | max. |               |   |
| 3.4.72                      | Tracker load capacitor           | $C_{Q\_T4}$               | 1            |                         |      | $\mu\text{F}$ | Ceramic type, minimum for stability                                 |
| <b>Voltage Tracker Q_T5</b> |                                  |                           |              |                         |      |               |   |
| 3.4.73                      | Output voltage tracking accuracy | $\Delta V_{Q\_T5}$        | -15          |                         | 5    | mV            | $V_{Q\_T5}-V_{Q\_LDO1}$ ;<br>$1\text{mA} < I_{Q\_T5} < 17\text{mA}$ |
| 3.4.74                      | Output voltage tracking accuracy | $\Delta V_{Q\_T5}$        |              | -10                     |      | mV            | $V_{Q\_T5}-V_{Q\_LDO5}$ ;<br>$I_{Q\_T5} = 17\text{mA}$              |
| 3.4.75                      | Overvoltage threshold            | $V_{OVQ\_T5}$             |              | $V_{Q\_T5, \text{nom}}$ |      | mV            | $I_{Q\_T5} = 0\text{mA}$ ; <sup>1)</sup>                            |
| 3.4.76                      | Undervoltage threshold           | $V_{UVQ\_T5}$             |              | $V_{Q\_T5}-15\text{mV}$ |      | mV            | <sup>1)</sup>   |
| 3.4.77                      | Current limit                    | $I_{Q\_T5 \text{ limit}}$ | 17           |                         | 30   | mA            | $V_{Q\_T5}=4\text{V}$   |
| 3.4.78                      | Ripple rejection                 | PSRR                      | 26           |                         |      | dB            | $f=330\text{kHz}$ ; <sup>1)</sup>                                   |
| 3.4.79                      | Tracker load capacitor           | $C_{Q\_T5}$               | 1            |                         |      | $\mu\text{F}$ | Ceramic type, minimum for stability                                 |
| <b>Voltage Tracker Q_T6</b> |                                  |                           |              |                         |      |               |   |
| 3.4.80                      | Output voltage tracking accuracy | $\Delta V_{Q\_T6}$        | -15          |                         | 5    | mV            | $V_{Q\_T6}-V_{Q\_LDO1}$ ;<br>$1\text{mA} < I_{Q\_T6} < 17\text{mA}$ |
| 3.4.81                      | Output voltage tracking accuracy | $\Delta V_{Q\_T6}$        |              | -10                     |      | mV            | $V_{Q\_T6}-V_{Q\_LDO6}$ ;<br>$I_{Q\_T6} = 17\text{mA}$              |
| 3.4.82                      | Overvoltage threshold            | $V_{OVQ\_T6}$             |              | $V_{Q\_T6, \text{nom}}$ |      | mV            | $I_{Q\_T6} = 0\text{mA}$ ; <sup>1)</sup>                            |

$-40 < T_j < 150 \text{ }^\circ\text{C}$ ;  $V_{IN}=13.5\text{V}$  unless otherwise specified

| Item                     | Parameter                   | Symbol              | Limit Values |                           |      | Unit          | Test Conditions  |
|--------------------------|-----------------------------|---------------------|--------------|---------------------------|------|---------------|--|
|                          |                             |                     | min.         | typ.                      | max. |               |  |
| 3.4.83                   | Undervoltage threshold      | $V_{UVQ\_T6}$       |              | $V_{Q\_T6} - 15\text{mV}$ |      | mV            | 1)   |
| 3.4.84                   | Current limit               | $I_{Q\_T6}$ limit   | 17           |                           | 30   | mA            | $V_{Q\_T6}=4\text{V}$  |
| 3.4.85                   | Ripple rejection            | PSRR                | 26           |                           |      | dB            | $f=330\text{kHz}$ ; 1)   |
| 3.4.86                   | Tracker load capacitor      | $C_{Q\_T6}$         | 1            |                           |      | $\mu\text{F}$ | Ceramic type, minimum for stability  |
| <b>Standby Regulator</b> |                             |                     |              |                           |      |               |  |
| 3.4.87                   | Output voltage              | $V_{Q\_STB}$        | 2.2          | 2.4                       | 2.6  | V             | $0\mu\text{A}$<br>$<I_{Q\_STB}<500\mu\text{A}$                                 |
| 3.4.88                   | Current limit               | $I_{Q\_STB}$ limit  | 1            | 3                         | 6    | mA            | $V_{Q\_STB}=2\text{V}$   |
| 3.4.89                   | Standby load capacitor      | $C_{Q\_STB}$        | 100          |                           |      | nF            | Ceramic type, minimum for stability  |
| <b>Off-Mode</b>          |                             |                     |              |                           |      |               |  |
| 3.4.90                   | Supply current from battery | $I_{q,off}$         |              | 10                        | 30   | $\mu\text{A}$ | $V_{IN}=13.5\text{V}$ ,<br>$V_{wake}=0\text{V}$ ,<br>$I_{Q\_STB}=0\mu\text{A}$ |
| 3.4.91                   | Supply current from battery | $I_{q,off}$         |              | 10                        | 30   | $\mu\text{A}$ | $V_{IN}=42\text{V}$ ,<br>$V_{wake}=0\text{V}$<br>$I_{Q\_STB}=0\mu\text{A}$     |
| 3.4.92                   | Turn on Wake-up threshold   | $V_{wake\ th, on}$  |              | 2.4                       | 2.8  | V             | $V_{wake}$ increasing  |
| 3.4.93                   | Turn off Wake-up threshold  | $V_{wake\ th, off}$ | 1.8          | 2.35                      |      | V             | $V_{wake}$ decreasing  |
| 3.4.94                   | Wake-up input current       | $I_{wake}$          |              | 50                        | 150  | $\mu\text{A}$ | $V_{wake}=5\text{V}$   |
| 3.4.95                   | Wake up input on time       | $t_{wake,min}$      | 4            | 10                        | 50   | $\mu\text{s}$ | $V_{wake} >$<br>$V_{wake\ th, on\ max}$ ; 1)                                   |
| <b>Reset R1</b>          |                             |                     |              |                           |      |               |  |

$-40 < T_j < 150 \text{ }^\circ\text{C}$ ;  $V_{IN}=13.5\text{V}$  unless otherwise specified

| Item            | Parameter                         | Symbol   | Limit Values |      |      | Unit          | Test Conditions                                      |
|-----------------|-----------------------------------|--|--------------|------|------|---------------|--|
|                 |                                   |  | min.         | typ. | max. |               |  |
| 3.4.96          | Reset threshold Q_LDO1            | $V_{RTH}$<br>$Q\_LDO1, de$                                 | 4.5          | 4.65 | 4.8  | V             | $V_{Q\_LDO1}$<br>decreasing                          |
| 3.4.97          | Reset threshold Q_LDO1            | $V_{RTH}$<br>$Q\_LDO1, in$                                 | 4.55         | 4.70 | 4.9  | V             | $V_{Q\_LDO1}$<br>increasing                          |
| 3.4.98          | Reset output low voltage          | $V_{R1L}$  |              |      | 0.4  | V             | $I_{R1}=1.6\text{mA}$ ;<br>$V_{Q\_LDO1}=5\text{V}$   |
| 3.4.99          | Reset output low voltage          | $V_{R1L}$  |              |      | 0.3  | V             | $I_{R1}=0.3\text{mA}$ ;<br>$V_{Q\_LDO1}=1\text{V}$   |
| 34.100          | Reset High leakage current        | $I_{R1H}$  |              |      | 1    | $\mu\text{A}$ |  |
| <b>Reset R2</b> |                                   |  |              |      |      |               |  |
| 34.101          | Reset threshold Q_LDO2            | $V_{RTH}$<br>$Q\_LDO2, de$                                 | 2.6          | 2.8  | 3.0  | V             | 3.3V mode;<br>$V_{Q\_LDO2}$<br>decreasing            |
| 34.102          | Reset threshold hysteresis Q_LDO2 | $V_{RTH}$<br>$Q\_LDO2, in$ -<br>$V_{RTH}$<br>$Q\_LDO2, de$ |              | 40   |      | mV            | 3.3V mode  |
| 34.103          | Reset threshold Q_LDO2            | $V_{RTH}$<br>$Q\_LDO2, de$                                 | 2.3          | 2.4  | 2.5  | V             | 2.6V mode;<br>$V_{Q\_LDO2}$<br>decreasing            |
| 34.104          | Reset threshold hysteresis Q_LDO2 | $V_{RTH}$<br>$Q\_LDO2, in$ -<br>$V_{RTH}$<br>$Q\_LDO2, de$ |              | 40   |      | mV            | 2.6V mode  |
| 34.105          | Reset output low voltage          | $V_{R2L}$  |              |      | 0.4  | V             | $I_{R2}=1.6\text{mA}$ ;<br>$V_{Q\_LDO2}=2.5\text{V}$ |
| 34.106          | Reset output low voltage          | $V_{R2L}$  |              |      | 0.3  | V             | $I_{R2}=0.3\text{mA}$ ;<br>$V_{Q\_LDO2}=1\text{V}$   |
| 34.107          | Reset High leakage current        | $I_{R2H}$  |              |      | 1    | $\mu\text{A}$ |  |

$-40 < T_j < 150 \text{ }^\circ\text{C}$ ;  $V_{IN}=13.5\text{V}$  unless otherwise specified

| Item            | Parameter                         | Symbol   | Limit Values |      |      | Unit           | Test Conditions   |
|-----------------|-----------------------------------|--|--------------|------|------|----------------|---|
|                 |                                   |  | min.         | typ. | max. |                |   |
| <b>Reset R3</b> |                                   |  |              |      |      |                |   |
| 34.108          | Reset threshold Q_LDO3            | $V_{RTH}$<br>$Q\_LDO3, de$                                 | 2.7          | 2.85 | 3.0  | V              | 3.3V mode;<br>$V_{Q\_LDO3}$<br>decreasing   |
| 34.109          | Reset threshold hysteresis Q_LDO3 | $V_{RTH}$<br>$Q\_LDO3, in -$<br>$V_{RTH}$<br>$Q\_LDO3, de$ |              | 40   |      | mV             | 3.3V mode   |
| 34.110          | Reset threshold Q_LDO3            | $V_{RTH}$<br>$Q\_LDO3, de$                                 | 4.0          | 4.2  | 4.5  | V              | 5V mode;<br>$V_{Q\_LDO3}$<br>decreasing   |
| 34.111          | Reset threshold hysteresis Q_LDO3 | $V_{RTH}$<br>$Q\_LDO3, in -$<br>$V_{RTH}$<br>$Q\_LDO3, de$ |              | 40   |      | mV             | 5V mode   |
| 34.112          | Reset output low voltage          | $V_{R3L}$  |              |      | 0.4  | V              | $I_{R3}=1.6\text{mA}$ ;<br>$V_{Q\_LDO3}=3.3\text{V}$  |
| 34.113          | Reset output low voltage          | $V_{R3L}$  |              |      | 0.3  | V              | $I_{R3}=0.3\text{mA}$ ;<br>$V_{Q\_LDO3}=1\text{V}$  |
| 34.114          | Reset High leakage current        | $I_{R3H}$  |              |      | 1    | $\mu\text{A}$  |   |
| 34.115          | Reset reaction time               | $t_{rr}$   | 1            | 2    | 10   | $\mu\text{s}$  | <sup>1)</sup><br>Valid for R1, R2<br>and R3   |
| 34.116          | Reset Delay Norm factor           | $t_{NORM,RES}$   | 0.75         | 1    | 1.25 | 1              |   |
| 34.117          | Reset Delay time                  | $t_{RES}$  | 0.75         | 1    | 1.25 | $t_{RES(SPI)}$ | Valid for R1, R2<br>and R3; $t_{RES(SPI)}$<br>is defined by the<br>SPI word (see<br>section 2.12) |
| <b>RAM Good</b> |                                   |  |              |      |      |                |   |
| 34.118          | $V_{Q1}$ threshold                | $V_{ThQ1}$   | 2.3          | 2.8  | 3.3  | V              |   |

$-40 < T_j < 150 \text{ }^\circ\text{C}$ ;  $V_{IN}=13.5\text{V}$  unless otherwise specified

| Item  | Parameter                    | Symbol                 | Limit Values        |                     |      | Unit | Test Conditions   |
|---|------------------------------|------------------------|---------------------|---------------------|------|------|---|
|   |                              |                        | min.                | typ.                | max. |      |   |
| 34.119  | $V_{Q2}$ threshold           | $V_{Th\ Q2}$           | 1.2                 | 1.4                 | 1.7  | V    | 3.3V mode   |
| 34.120  | $V_{Q2}$ threshold           | $V_{Th\ Q2}$           | 1.2                 | 1.4                 | 1.7  | V    | 2.6V mode; <sup>1)</sup>  |
| <b>Window Watchdog</b>                          |                              |                        |                     |                     |      |      |   |
| 34.121  | Closed window time tolerance | $t_{CW\_tol}$          | 0.75                | 1                   | 1.25 |      | Multiply with watchdog window time set by SPI to obtain the limits (2.12) |
| 34.122  | Open window time tolerance   | $t_{OW\_tol}$          | 0.75                | 1                   | 1.25 |      | Multiply with watchdog window time set by SPI to obtain the limits (2.12) |
| 34.123  | Watchdog reset low time      | $t_{WRL}$              |                     | $t_{RES}$           |      |      |   |
| 34.124  | Watchdog reset delay time    | $t_{SR}$               |                     | $t_{CW}/2$          |      |      |   |
| <b>Error Output <math>\overline{ERR}</math></b> |                              |                        |                     |                     |      |      |   |
| 34.125  | H-output voltage level       | $V_{\overline{ERR},H}$ | $V_{Q\_LDO1} - 2.0$ | $V_{Q\_LDO1} - 0.7$ | –    | V    | $I_{\overline{ERR}, H} = 1 \text{ mA}$                                    |
| 34.126  | L-output voltage level       | $V_{\overline{ERR},L}$ | –                   | 0.3                 | 0.5  | V    | $I_{\overline{ERR}, L} = - 1.6 \text{ mA}$                                |
| <b>SPI</b>                                      |                              |                        |                     |                     |      |      |   |
| 34.127  | SPI clock frequency          | $f_{CLK}$              | 0                   |                     | 2.5  | MHz  | Production test up to 1MHz; 2.5MHz <sup>1)</sup>                          |
| <b>SPI Input DI</b>                             |                              |                        |                     |                     |      |      |   |

-40 < T<sub>j</sub> < 150 °C; V<sub>IN</sub>=13.5V unless otherwise specified

| Item                            | Parameter                   | Symbol           | Limit Values |      |      | Unit                     | Test Conditions                                 |
|---------------------------------|-----------------------------|------------------|--------------|------|------|--------------------------|---|
|                                 |                             |                  | min.         | typ. | max. |                          |   |
| 34.128                          | H-input voltage threshold   | V <sub>IH</sub>  | –            | 40   | 70   | % of V <sub>Q_LDO1</sub> | –   |
| 34.129                          | L-input voltage threshold   | V <sub>IL</sub>  | 20           | 36   | –    | % of V <sub>Q_LDO1</sub> | –   |
| 34.130                          | Hysteresis of input voltage | V <sub>IHY</sub> | 50           | 200  | 500  | mV                       | 1)  |
| 34.131                          | Pull down current           | I <sub>I</sub>   | 5            | 25   | 100  | μA                       | V <sub>DI</sub> = 0.2 *<br>V <sub>Q_LDO1</sub>  |
| 34.132                          | Input capacitance           | C <sub>I</sub>   | –            | 10   | 15   | pF                       | 0 V < V <sub>Q_LDO1</sub> < 5.25 V              |
| 34.133                          | Input signal rise time      | t <sub>r</sub>   | –            | –    | 200  | ns                       | 1)  |
| 34.134                          | Input signal fall time      | t <sub>f</sub>   | –            | –    | 200  | ns                       | 1)  |
| <b>SPI Clock Input CLK</b>      |                             |                  |              |      |      |                          |   |
| 34.135                          | H-input voltage threshold   | V <sub>IH</sub>  | –            | 40   | 70   | % of V <sub>Q_LDO1</sub> | –   |
| 34.136                          | L-input voltage threshold   | V <sub>IL</sub>  | 20           | 36   | –    | % of V <sub>Q_LDO1</sub> | –   |
| 34.137                          | Hysteresis of input voltage | V <sub>IHY</sub> | 50           | 200  | 500  | mV                       | 1)  |
| 34.138                          | Pull down current           | I <sub>I</sub>   | 5            | 25   | 100  | μA                       | V <sub>CLK</sub> = 0.2 *<br>V <sub>Q_LDO1</sub> |
| 34.139                          | Input capacitance           | C <sub>I</sub>   | –            | 10   | 15   | pF                       | 0 V < V <sub>Q_LDO1</sub> < 5.25 V              |
| 34.140                          | Input signal rise time      | t <sub>r</sub>   | –            | –    | 200  | ns                       | 1)  |
| 34.141                          | Input signal fall time      | t <sub>f</sub>   | –            | –    | 200  | ns                       | 1)  |
| <b>SPI Chip Select Input CS</b> |                             |                  |              |      |      |                          |   |



$-40 < T_j < 150 \text{ }^\circ\text{C}$ ;  $V_{IN}=13.5\text{V}$  unless otherwise specified

| Item                     | Parameter                   | Symbol        | Limit Values        |                     |      | Unit               | Test Conditions  |
|--------------------------|-----------------------------|---------------|---------------------|---------------------|------|--------------------|--|
|                          |                             |               | min.                | typ.                | max. |                    |  |
| 34.142                   | H-input voltage threshold   | $V_{IH}$      | –                   | 39                  | 70   | % of $V_{Q\_LDO1}$ | –  |
| 34.143                   | L-input voltage threshold   | $V_{IL}$      | 20                  | 35                  | –    | % of $V_{Q\_LDO1}$ | –  |
| 34.144                   | Hysteresis of input voltage | $V_{IHY}$     | 50                  | 200                 | 500  | mV                 | 1)   |
| 34.145                   | Pull up current at pin CS   | $I_{i,CS}$    | – 100               | – 25                | – 5  | $\mu\text{A}$      | $V_{CS}^- = 0.2 * V_{Q\_LDO1}$   |
| 34.146                   | Input capacitance           | $C_i$         | –                   | 10                  | 15   | pF                 | $0 \text{ V} < V_{Q\_LDO1} < 5.25 \text{ V}$                               |
| 34.147                   | Input signal rise time      | $t_r$         | –                   | –                   | 200  | ns                 | 1)   |
| 34.148                   | Input signal fall time      | $t_f$         | –                   | –                   | 200  | ns                 | 1)   |
| <b>Logic Output DO</b>   |                             |               |                     |                     |      |                    |  |
| 34.149                   | H-output voltage level      | $V_{DOH}$     | $V_{Q\_LDO1} - 1.0$ | $V_{Q\_LDO1} - 0.8$ | –    | V                  | $I_{DOH} = 1 \text{ mA}$   |
| 34.150                   | L-output voltage level      | $V_{DOL}$     | –                   | 0.2                 | 0.4  | V                  | $I_{DOL} = -1.6 \text{ mA}$  |
| 34.151                   | Tri-state leakage current   | $I_{DO\_TRI}$ | – 10                | –                   | 10   | $\mu\text{A}$      | $V_{CS}^- = V_{Q\_LDO1}$ ;<br>$0 \text{ V} < V_{DO} < V_{Q\_LDO1}$         |
| 34.152                   | Tri-state input capacitance | $C_{DO}$      | –                   | 10                  | 15   | pF                 | $V_{CS}^- = V_{Q\_LDO1}$ ;<br>$0 \text{ V} < V_{Q\_LDO1} < 5.25 \text{ V}$ |
| <b>Data Input Timing</b> |                             |               |                     |                     |      |                    |  |
| 34.153                   | Clock period                | $t_{pCLK}$    | 1000                | –                   | –    | ns                 | 1)   |

$-40 < T_j < 150 \text{ }^\circ\text{C}$ ;  $V_{IN}=13.5\text{V}$  unless otherwise specified

| Item                      | Parameter                            | Symbol           | Limit Values |      |      | Unit             | Test Conditions  |
|---------------------------|--------------------------------------|------------------|--------------|------|------|------------------|--|
|                           |                                      |                  | min.         | typ. | max. |                  |  |
| 34.154                    | Clock high time                      | $t_{CLKH}$       | 500          | –    | –    | ns               | 1)   |
| 34.155                    | Clock low time                       | $t_{CLKL}$       | 500          | –    | –    | ns               | 1)   |
| 34.156                    | Clock low before $\overline{CS}$ low | $t_{bef}$        | 500          | –    | –    | ns               | 1)   |
| 34.157                    | $\overline{CS}$ setup time           | $t_{lead}$       | 500          | –    | –    | ns               | 1)   |
| 34.158                    | CLK setup time                       | $t_{lag}$        | 500          | –    | –    | ns               | 1)   |
| 34.159                    | Clock low after $\overline{CS}$ high | $t_{beh}$        | 500          | –    | –    | ns               | 1)   |
| 34.160                    | DI setup time                        | $t_{DISU}$       | 250          | –    | –    | ns               | 1)   |
| 34.161                    | DI hold time                         | $t_{DIHO}$       | 250          | –    | –    | ns               | 1)   |
| <b>Data Output Timing</b> |                                      |                  |              |      |      |                  |  |
| 34.162                    | DO rise time                         | $t_{rDO}$        | –            | 50   | 100  | ns               | $C_L = 100 \text{ pF}$                                       |
| 34.163                    | DO fall time                         | $t_{fDO}$        | –            | 50   | 100  | ns               | $C_L = 100 \text{ pF}$                                       |
| 34.164                    | DO enable time                       | $t_{ENDO}$       | –            | –    | 250  | ns               | low impedance  |
| 34.165                    | DO disable time                      | $t_{DISDO}$      | –            | –    | 250  | ns               | high impedance   |
| 34.166                    | DO valid time                        | $t_{VADO}$       | –            | 100  | 250  | ns               | $V_{DO} < 10\%$<br>$V_{DO} > 90\%$<br>$C_L = 100 \text{ pF}$ |
| <b>General</b>            |                                      |                  |              |      |      |                  |  |
| 34.167                    | Temperature warning flag             | $T_{J,Flag}$     |              | 140  |      | $^\circ\text{C}$ | 2)   |
| 34.168                    | Over Temperature shutdown            | $T_{J,Shutdown}$ | 150          | 170  | 200  | $^\circ\text{C}$ | 2)   |

$-40 < T_j < 150 \text{ }^\circ\text{C}$ ;  $V_{IN}=13.5\text{V}$  unless otherwise specified

| Item   | Parameter                            | Symbol                        | Limit Values |      |      | Unit | Test Conditions |
|--------|--------------------------------------|-------------------------------|--------------|------|------|------|-----------------|
|        |                                      |                               | min.         | typ. | max. |      |                 |
| 34.169 | Over-Temperature shutdown Hysteresis | $\Delta T_{sd\_hys}$          |              | 30   |      | K    |                 |
| 34.170 | DeltaTW to TSD                       | $T_{J,Shutdown} - T_{J,Flag}$ |              | 20   |      | K    |                 |

- 1) Specified by design, not subject to production test
- 2) Simulated at wafer test only, not absolutely measured

#### 4 Typical performance characteristics

Buck converter switching frequency vs. junction temperature

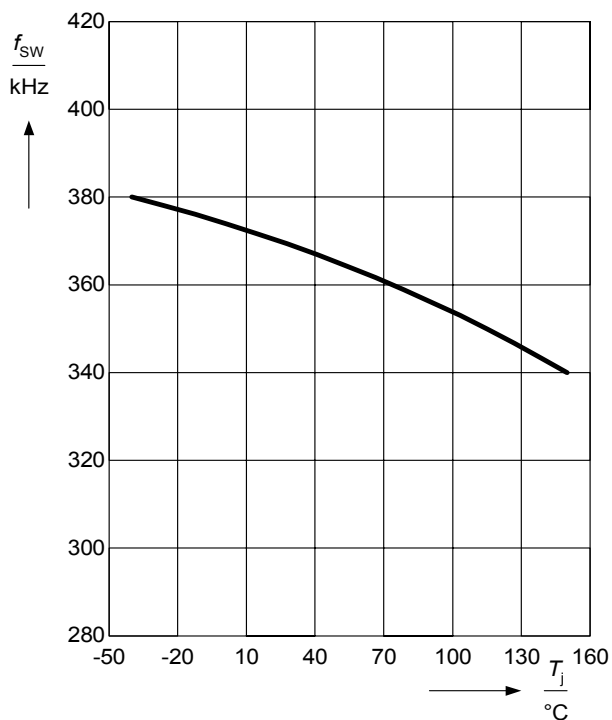

Buck converter output voltage at 1.5A load vs. junction temperature

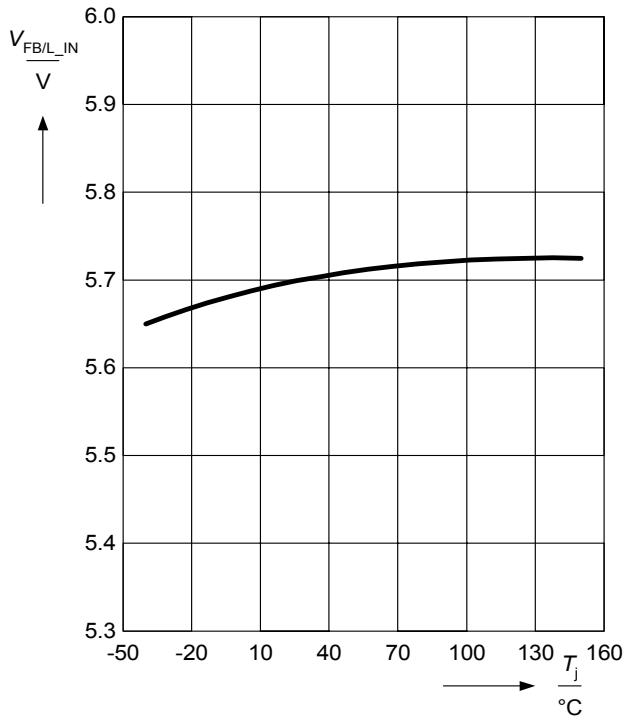

Buck converter current limit vs. junction temperature

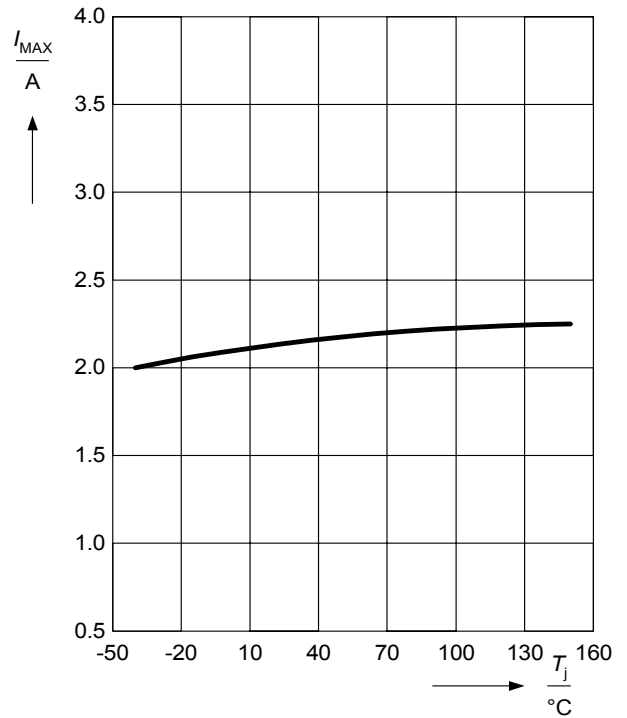

Buck converter DMOS on-resistance vs. junction temperature

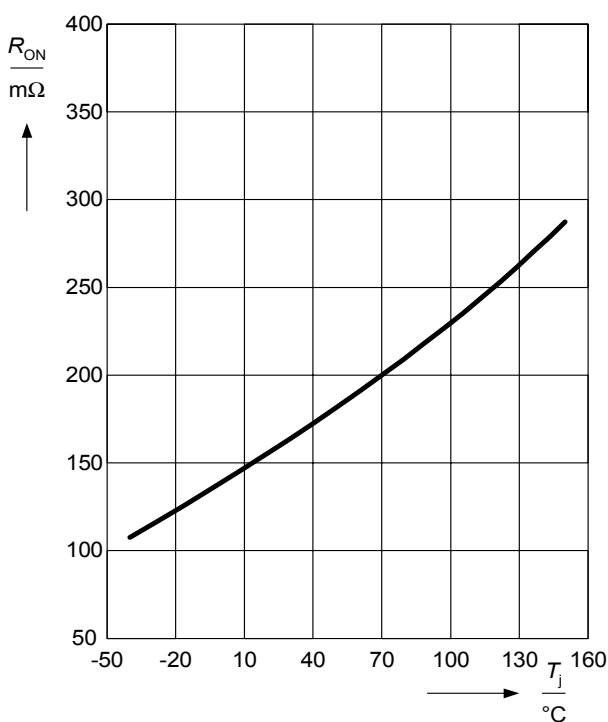

Start-up bootstrap charging current vs. junction temperature

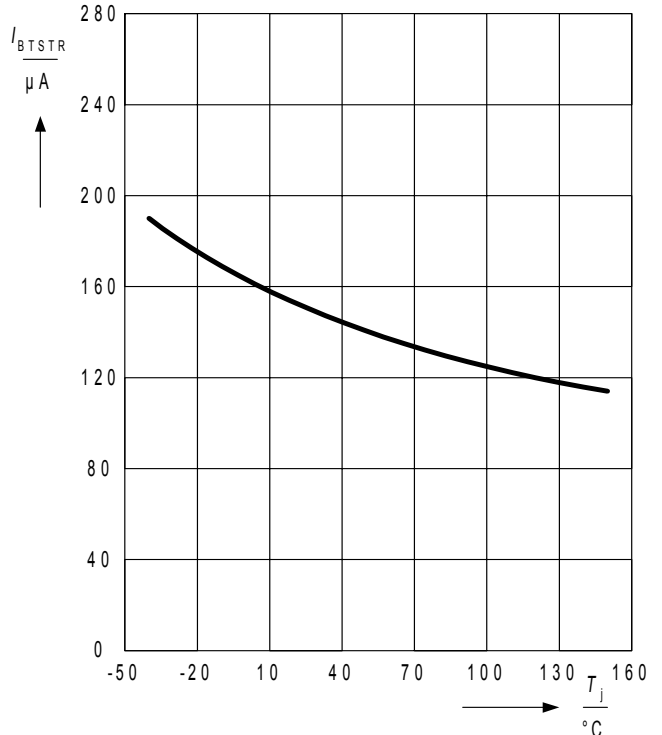

Bootstrap UV lockout, turn on threshold vs. junction temperature

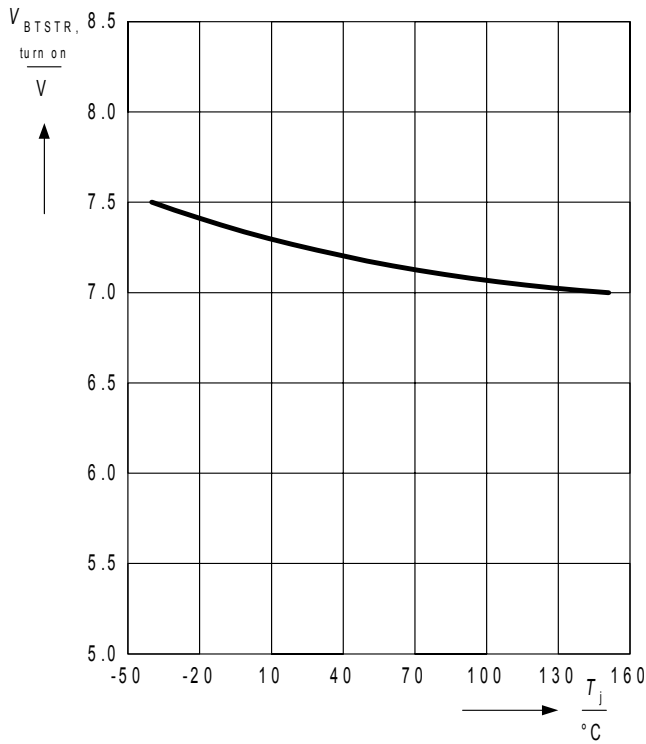

Q\_LDO1 output voltage at 800mA load vs. junction temperature

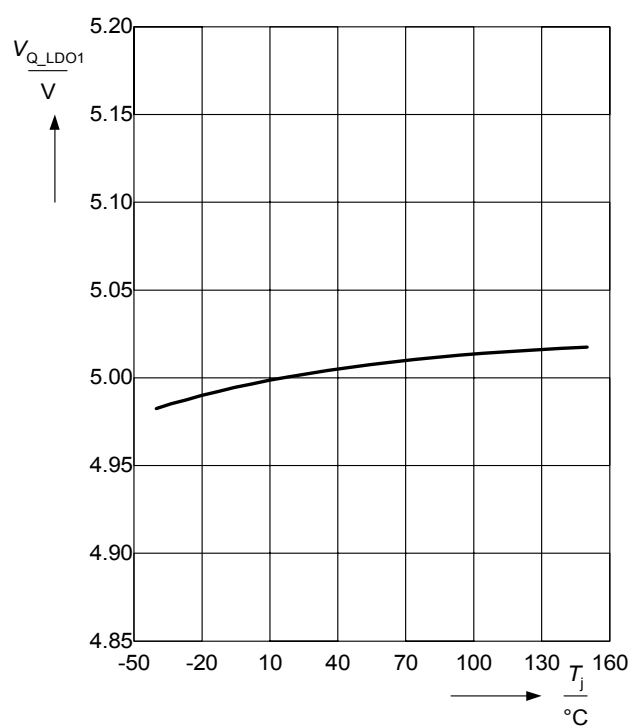

Device wake up thresholds vs. junction temperature

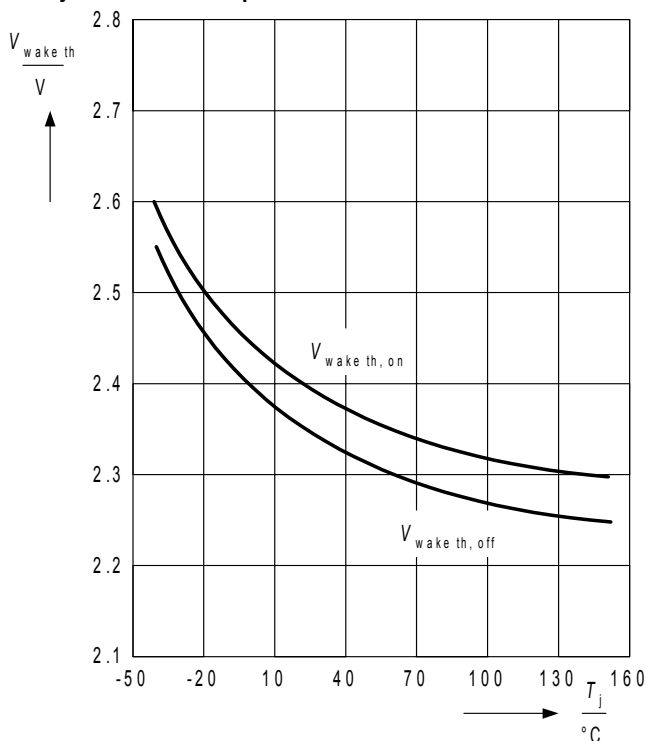

Reset1 threshold at decreasing V\_LDO1 vs. junction temperature

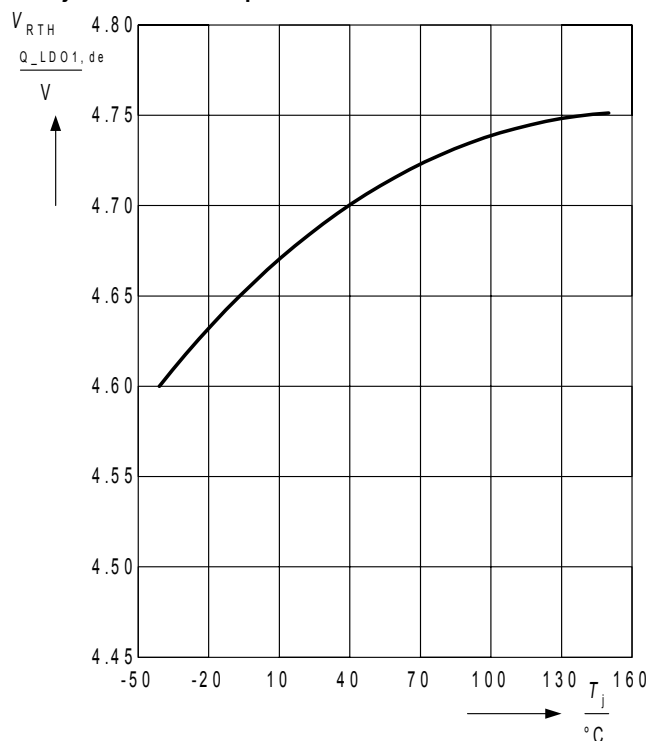

Q\_LDO1 current limit vs. junction temperature

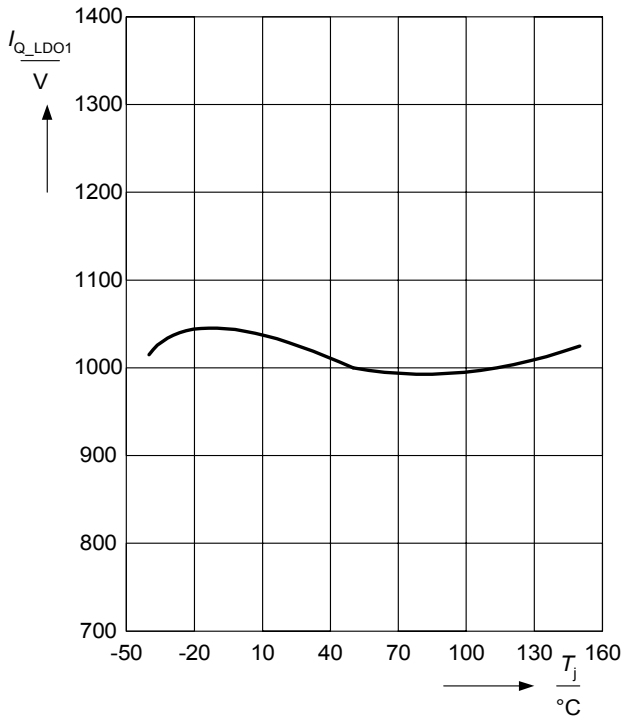

Q\_LDO2 current limit (2.6V mode) vs. junction temperature

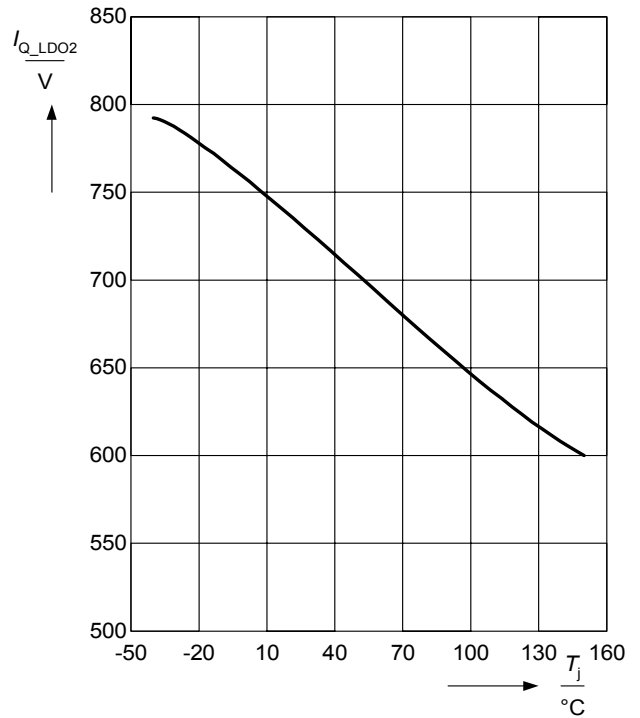

Q\_LDO2 output voltage at 400mA load (2.6V mode) vs. junction temperature

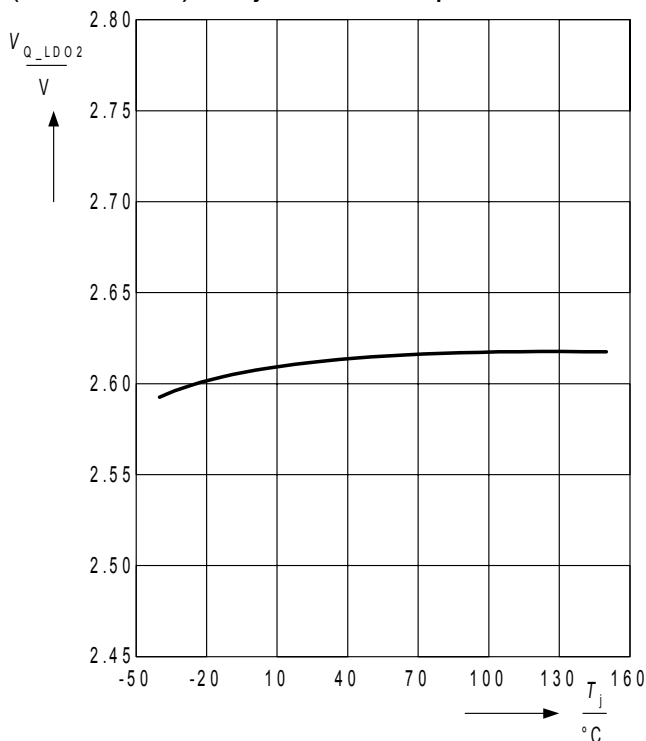

Q\_LDO3 output voltage at 300mA load (3.3V mode) vs. junction temperature

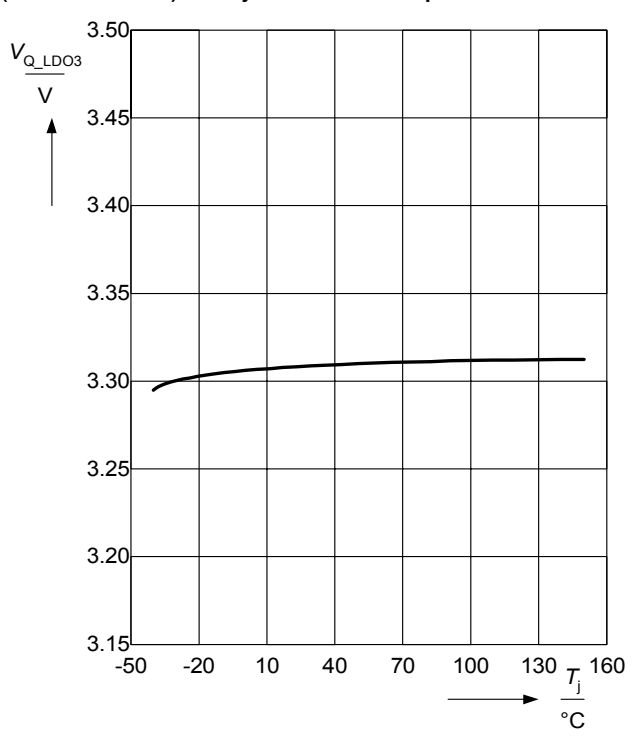

Reset2 threshold at decreasing V\_LDO2 (2.6V mode) vs. junction temperature

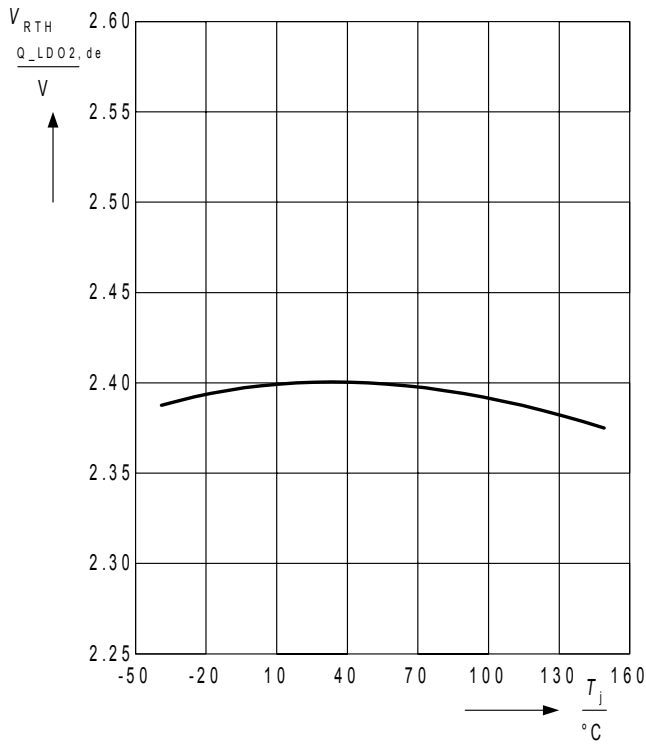

Reset3 threshold at decreasing V\_LDO3 (3.3V mode) vs. junction temperature

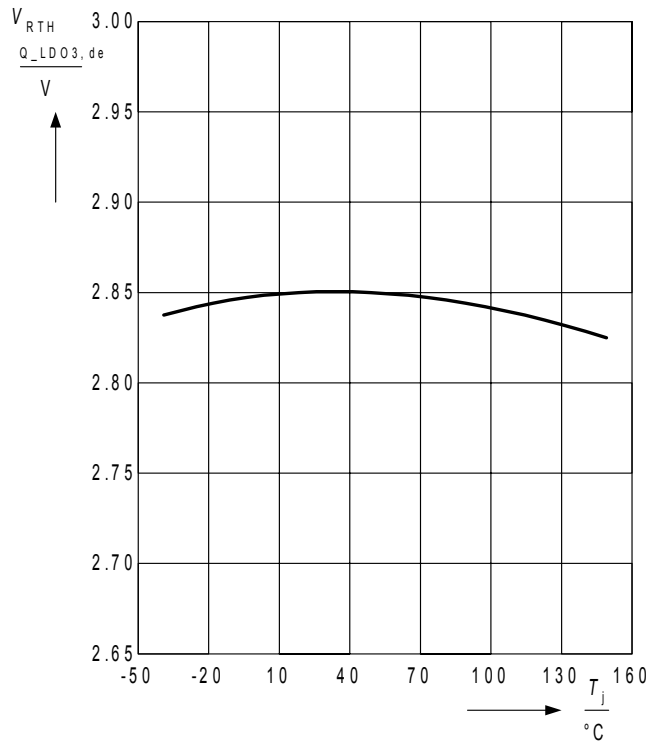

Q\_LDO3 current limit (3.3V mode) vs. junction temperature

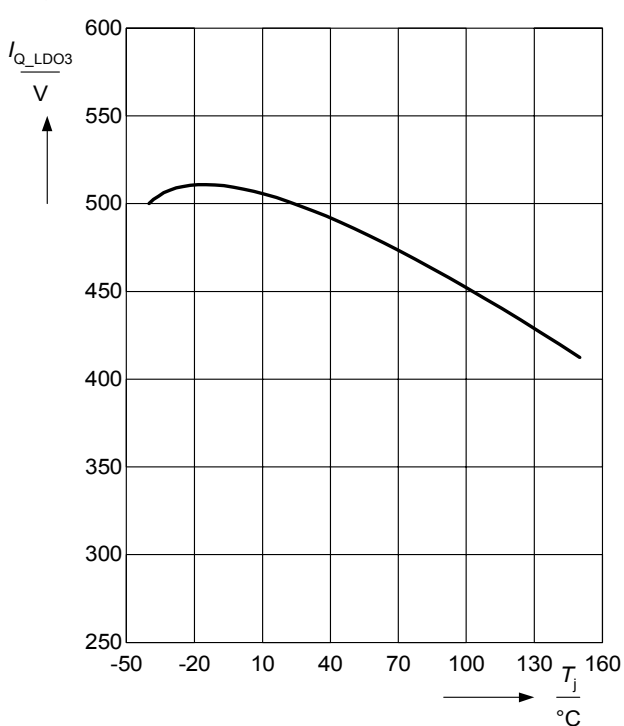

Tracker current limit vs. junction temperature

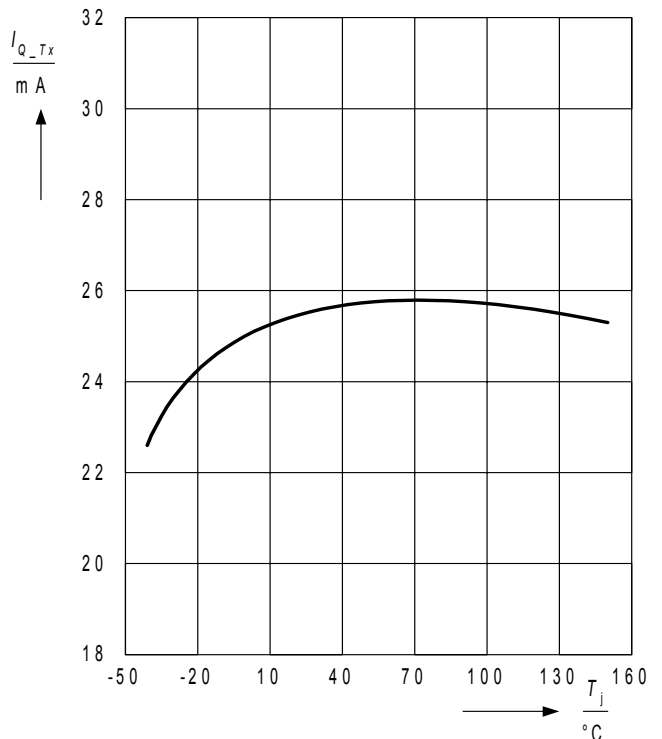

Tracker accuracy with respect to V\_LDO1 vs. junction temperature

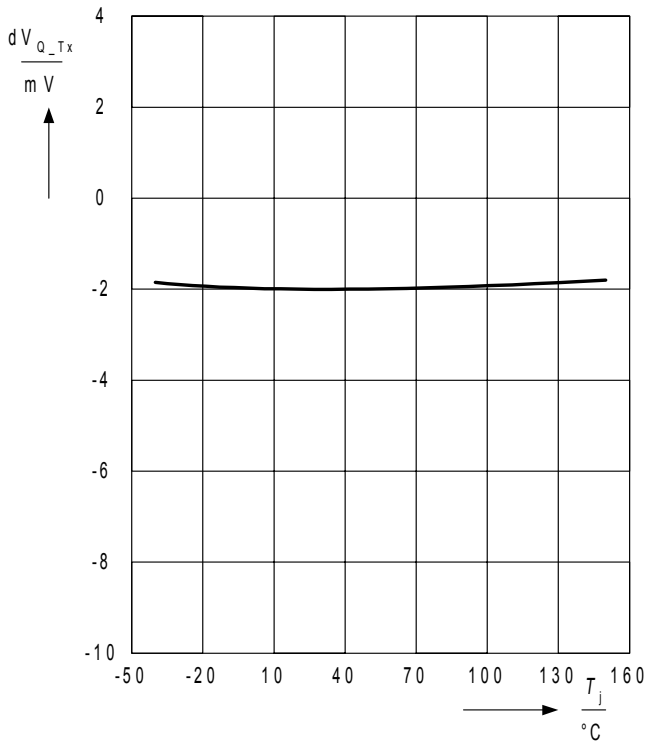

Q\_STB current limit vs. junction temperature

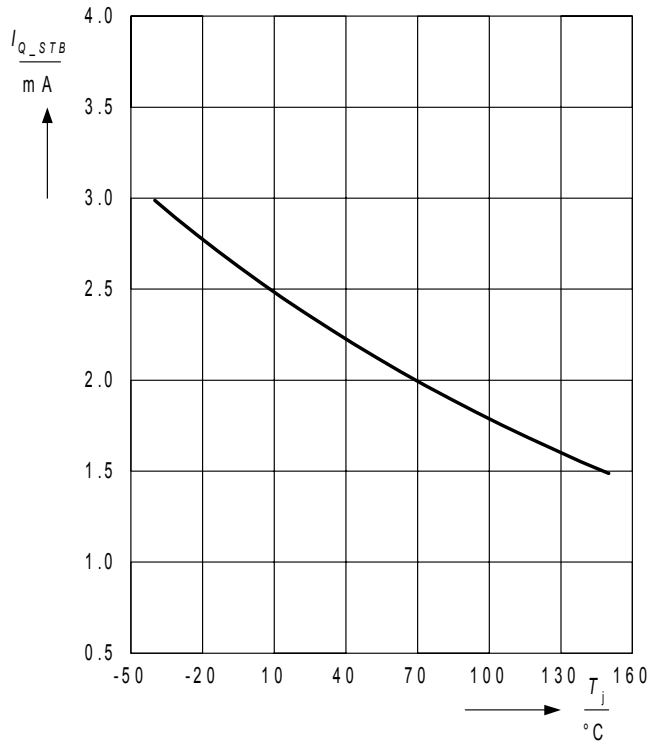

Q\_STB output voltage at 500µA load vs. junction temperature

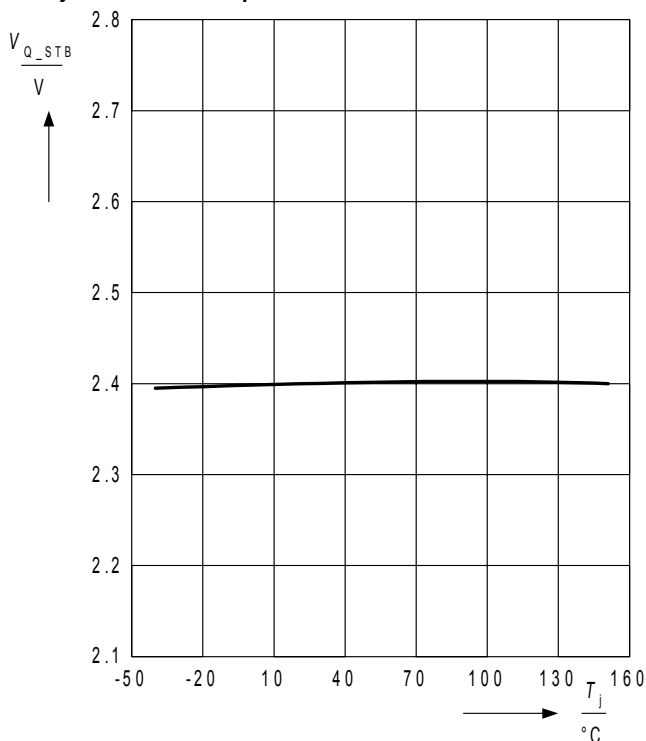

Device current consumption in off mode vs. junction temperature

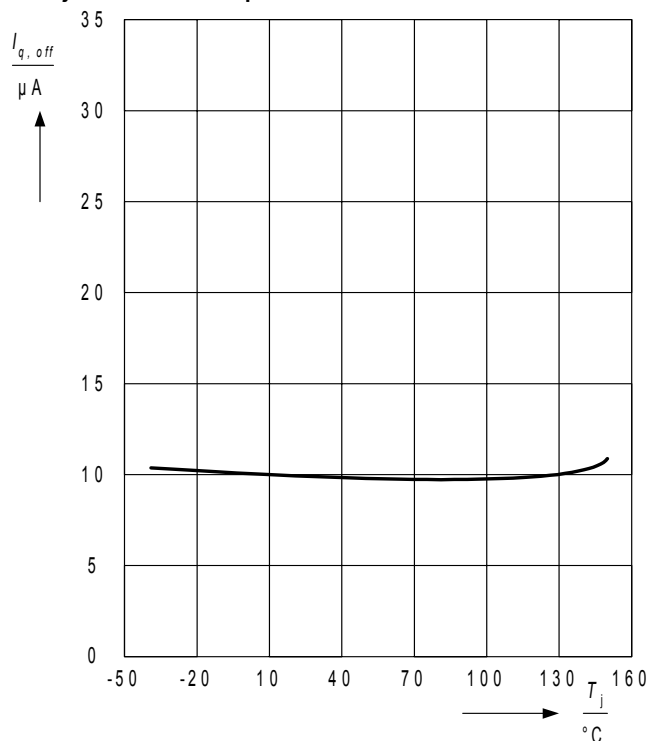



## 5 Application Information

### 5.1 Application Diagram

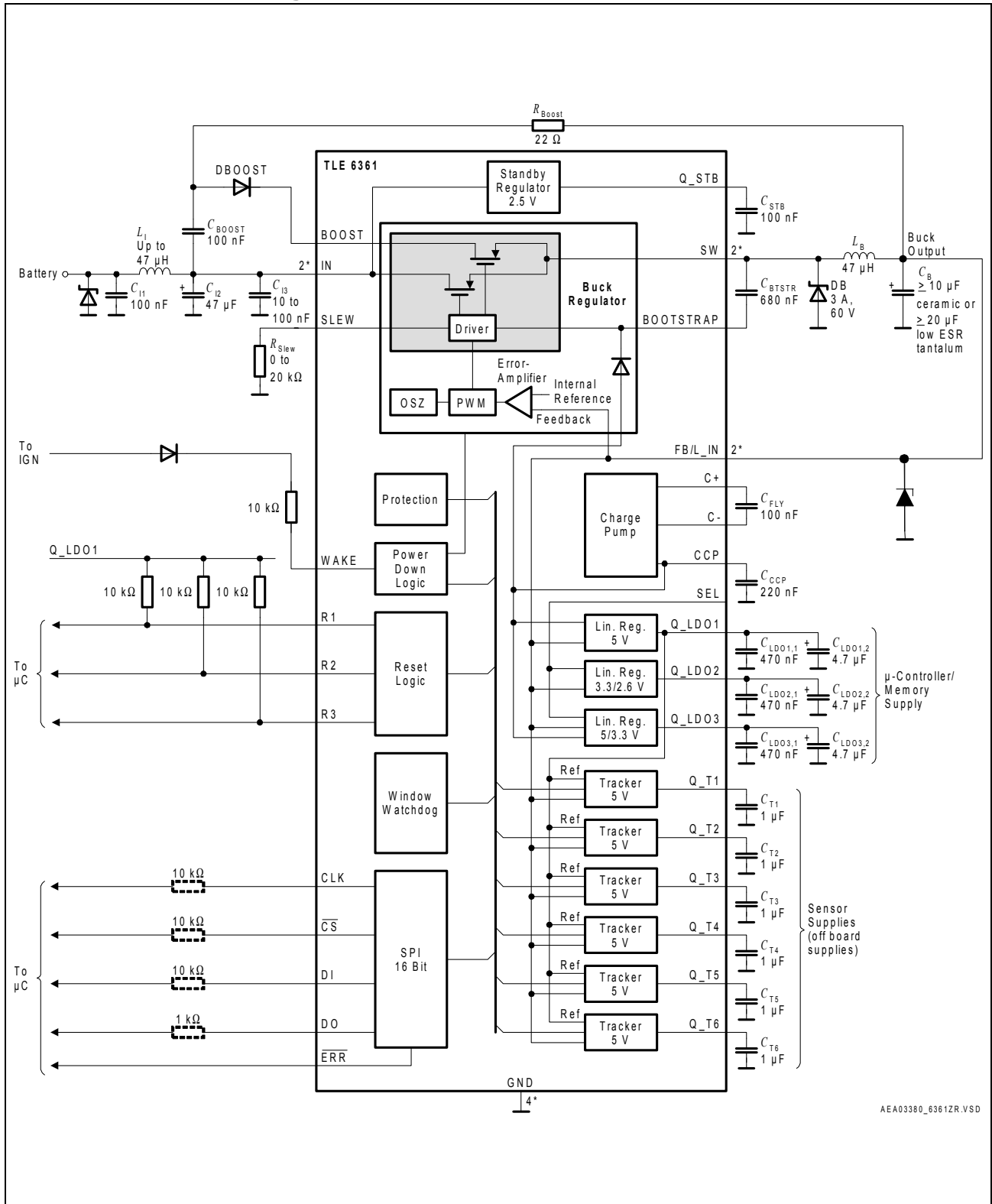

Figure 14 Application Diagram

## 5.2 Buck converter circuit

A typical choice of external components for the buck converter is given in figure 14. For basic operation of the buck converter the input capacitor  $C_{I2}$ , the bootstrap capacitor  $C_{BTP}$ , the catch diode  $D_B$ , the inductance  $L_B$ , the output capacitor  $C_B$  and the charge pump capacitors  $C_{FLY}$  and  $C_{CCP}$  are necessary.

The additional components shown on top of the circuit lower the electromagnetic emission ( $L_I$ ,  $C_{I1}$ ,  $C_{I3}$ ,  $R_{Slew}$ ) and the switching losses ( $R_{Boost}$ ,  $C_{Boost}$ ,  $D_{Boost}$ ). For 12V battery systems the switching loss minimization feature might not be used. In that case the Boost pin (33) is connected directly to the IN pins (32, 30) and the components  $R_{Boost}$ ,  $C_{Boost}$  and  $D_{Boost}$  are left away

### 5.2.1 Buck inductance ( $L_B$ ) selection:

The inductance value determines together with the input voltage, the output voltage and the switching frequency the current ripple which occurs during normal operation of the step down converter. This current ripple is important for the all over ripple at the output of the switching converter.

As a rule of thumb this current ripple  $\Delta I$  is chosen between 10% and 50% of the load current.

$$L = \frac{(V_I - V_{OUT}) \cdot V_{OUT}}{f_{SW} \cdot V_I \cdot \Delta I}$$

For optimum operation of the control loop of the Buck converter the inductance value should be in the range indicated in section 3.3, recommended operation range.

When picking finally the inductance of a certain supplier (Epcos, Coilcraft etc.) the saturation current has to be considered. With a maximum current limit of the Buck converter of 3.2A an inductance with a minimum saturation current of 3.2A has to be chosen.

### 5.2.2 Buck output capacitor ( $C_B$ ) selection:

The choice of the output capacitor effects straight to the minimum achievable ripple which is seen at the output of the buck converter. In continuous conduction mode the ripple of the output voltage equals:

$$V_{\text{Ripple}} = \Delta I \cdot \left( R_{\text{ESRCB}} + \frac{1}{8 \cdot f_{\text{SW}} \cdot C_B} \right)$$

From the formula it is recognized that the ESR has a big influence in the total ripple at the output, so ceramic types or low ESR tantalum capacitors are recommended for the application.

One other important thing to note are the requirements for the resonant frequency of the output LC-combination. The choice of the components L and C have to meet also the specified range given in section 3.3 otherwise instabilities of the regulation loop might occur.

### 5.2.3 Input capacitor ( $C_{I2}$ ) selection:

At high load currents, where the current through the inductance flows continuously, the input capacitor is exposed to a square wave current with its duty cycle  $V_{\text{OUT}}/V_I$ . To prevent a high ripple to the battery line a capacitor with low ESR should be used. The maximum RMS current which the capacitor has to withstand is calculated to:

$$I_{\text{RMS}} = I_{\text{LOAD}} \cdot \sqrt{\frac{V_{\text{OUT}}}{V_{\text{IN}}}} \cdot \sqrt{1 + \frac{1}{3} \cdot \left( \frac{\Delta I}{2 \cdot I_{\text{LOAD}}} \right)^2}$$

### 5.2.4 Freewheeling diode / catch diode ( $D_B$ )

For lowest power loss in the freewheeling path Schottky diodes are recommended. With those types the reverse recovery charge is negligible and a fast handover from freewheeling to forward conduction mode is possible. Depending on the application (12V battery systems) 40V types could be also used instead of the 60V diodes.

A fast recovery diode with recovery times in the range of 30ns can be also used if smaller junction capacitance values (smaller spikes) are desired, the slew resistor should be set in this case between 10 and 20k $\Omega$ .

### 5.2.5 Bootstrap capacitor ( $C_{BTP}$ )

The voltage at the Bootstrap capacitor does not exceed 15V, a ceramic type with a minimum of 2% of the buck output capacitance and voltage class 16V would be sufficient.

### 5.2.6 External charge pump capacitors ( $C_{FLY}$ , $C_{CCP}$ )

Out of the feedback voltage the charge pump generates a voltage between 8 and 10V. The fly capacitor connected between C+ and C- is charged with the feedback voltage level and discharged to achieve the (almost) double voltage level at CCP.  $C_{FLY}$  is chosen to 100nF and  $C_{CCP}$  to 220nF, both ceramic types.

The connection of CCP to a voltage source of e.g. 7V (take care of the maximum ratings!) via a diode improves the start-up behavior at very low battery voltage. The diode with the cathode on CCP has to be used in order to avoid any influence of the voltage source to the device's operation and vice versa.

### 5.2.7 Input filter components for reduced EME ( $C_{I1}$ , $C_{I2}$ , $C_{I3}$ , $L_I$ , $R_{Slew}$ )

At the input of Buck converters a square wave current is observed causing electromagnetic interference on the battery line. The emission to the battery line consists on one hand of components of the switching frequency (fundamental wave) and its harmonics and on the other hand of the high frequency components derived from the current slope. For proper attenuation of those interferers a  $\pi$ -type input filter structure is recommended which is built up with inductive ( $L_I$ ) and capacitive components ( $C_{I1}$ ,  $C_{I2}$ ,  $C_{I3}$ ). The inductance can be chosen up to the value of the Buck converter inductance, higher values might not be necessary,  $C_{I1}$  and  $C_{I3}$  should be ceramic types and for  $C_{I2}$  an input capacitance with very low ESR should be chosen and placed as close to the input of the Buck converter as possible.

Inexpensive input filters show due to their parasitics a notch filter characteristic, which means basically that the lowpass filter acts from a certain frequency as a highpass filter and means further that the high frequency components are not attenuated properly. For that reason the TLE 6361 G offers the possibility of current slope adjustment. The current transition time can be set by the external slew resistor to times between 20ns and 80ns by varying the resistor value between 0 $\Omega$  (fastest transition) and 20k $\Omega$  (slowest transition).

### 5.2.8 Feedback circuit for minimum switching loss ( $R_{Boost}$ , $C_{Boost}$ , $D_{Boost}$ )

To decrease the switching losses to a minimum the external components  $R_{Boost}$ ,  $C_{Boost}$  and  $D_{Boost}$  are needed. The current through the feedback resistor  $R_{Boost}$  is about a few mA where the Diode  $D_{Boost}$  and the capacitor  $C_{Boost}$  run a part of the load current.

If this feature is not needed the three components are not needed and the Boost pin (33) can be connected directly to the IN pins(32, 30).

### 5.3 Reverse polarity protection

The Buck converter is due to the parasitic source drain diode of the DMOS not reverse polarity protected. Therefore, as an example, the reverse polarity diode is shown in the application circuit, in general the reverse polarity protection can be done in different ways.

### 5.4 Linear voltage regulators ( $C_{LDO1, 2, 3}$ )

As indicated before the linear regulators show stable operation with a minimum of 470nF ceramic capacitors. To avoid a high ripple at the output due to load steps this output cap might have to be increased to some few  $\mu\text{F}$  capacitors.

### 5.5 Linear voltage trackers ( $C_{T1,2,3,4,5,6}$ )

The voltage trackers require at their outputs 1 $\mu\text{F}$  ceramic capacitors each to avoid some oscillation at the output. If needed the tracker outputs can be connected in parallel, in that the output capacitor increases linear according to the number of parallel outputs.

### 5.6 Reset outputs (R1,2,3)

The undervoltage/watchdog reset outputs are open drain structures and require external pull up resistors in the range of 10k $\Omega$  to the  $\mu\text{C}$  I/O voltage rail.

**5.7 Components recommendation - overview**

| <b>Device</b> | <b>Type</b>       | <b>Supplier</b> | <b>Remark</b>                             |
|---------------|-------------------|-----------------|---|
| $L_I$         | B82479 series     | EPCOS           | 10-1000 $\mu$ H; 4.3-0.56A                |
|               | B82464-A4 series  | EPCOS           | 1-1000 $\mu$ H; 6.8-0.3A                  |
|               | DO3340P series    | Coilcraft       | 10-1000 $\mu$ H; 8.0-0.8A                 |
|               | DO5022P series    | Coilcraft       | 1-1000 $\mu$ H; 20.0-1.0A                 |
|               | DS5022P series    | Coilcraft       | 10-1000 $\mu$ H; 8.0-0.8A                 |
|               | SLF1275T-330M3R2  | TDK             | 33 $\mu$ H, 3.2A                          |
|               | $C_{I1}$          | Ceramic         | various                                   |
| $C_{I2}$      | Low ESR tantalum  | various         | 47 $\mu$ F, 60V                           |
| $C_{I3}$      | Ceramic           | various         | 10nF to 100nF, 60V                        |
| $D_{Boost}$   | S3B               | various         |   |
| $L_B$         | B82479 series     | EPCOS           | 10-1000 $\mu$ H; 4.3-0.56A                |
|               | B82464-A4 series  | EPCOS           | 1-1000 $\mu$ H; 6.8-0.3A                  |
|               | DO3340P series    | Coilcraft       | 10-1000 $\mu$ H; 8.0-0.8A                 |
|               | DO5022P series    | Coilcraft       | 1-1000 $\mu$ H; 20.0-1.0A                 |
|               | DS5022P series    | Coilcraft       | 10-1000 $\mu$ H; 8.0-0.8A                 |
|               | $C_{BTP}$         | Ceramic         | various                                   |
| $D_B$         | MBRD360           | Motorola        | Schottky, 60V, 3A                         |
|               | MBRD340           | Motorola        | Schottky, 40V, 3A                         |
|               | SS34              | various         | Schottky, 40V, 3A                         |
| $C_B$         | B45197-A2226      | EPCOS           | Low ESR Tantalum, 22 $\mu$ F, 10V, C-case |
|               | 2 * LMK316BJ475ML | Taiyo Yuden     | Ceramic X7R, 4.7 $\mu$ F, 10V             |
|               | C3216X7R1C106M    | TDK             | Ceramic X7R, 10 $\mu$ F, 16V              |
|               | TPSC476K010R350   | AVX             | Low ESR Tantalum, 47 $\mu$ F, 10V, C-case |
| $C_{LDOx}$    | Ceramic           | various         | 470nF, 10V                                |
| $C_{Tx}$      | Ceramic           | various         | 1 $\mu$ F, 60V                            |

## 5.8 Layout recommendation

The most sensitive points for Buck converters - when considering the layout - are the nodes at the input and the output of the Buck switch, the DMOS transistor.

For proper operation the external catch diode and Buck inductance have to be connected as close as possible to the SW pins (29, 31). Best suitable for the connection of the cathode of the Schottky diode and one terminal of the inductance would be a small plain located next to the SW pins.

The GND connection of the catch diode must be also as short as possible. In general the GND level should be implemented as surface area over the whole PCB as second layer, if necessary as third layer.

The pin FB/L\_IN is sensitive to noise. With an appropriate layout the Buck output capacitor helps to avoid noise coupling to this pin. Also filtering of steep edges at the supply voltage pin e.g. as shown in the application diagram is mandatory.  $C_{12}$  may either be a low ESR Tantalum capacitor or a ceramic capacitor. A minimum capacitance of  $10\mu\text{F}$  is recommended for  $C_{12}$ .

To obtain the optimum filter capability of the input  $\pi$ -filter it has to be located also as close as possible to the IN pins, at least the ceramic capacitor  $C_{13}$  should be next to those pins.

**Package Outlines**

**P-DSO-36-12**

SMD = Surface Mounted Device

Dimensions in mm

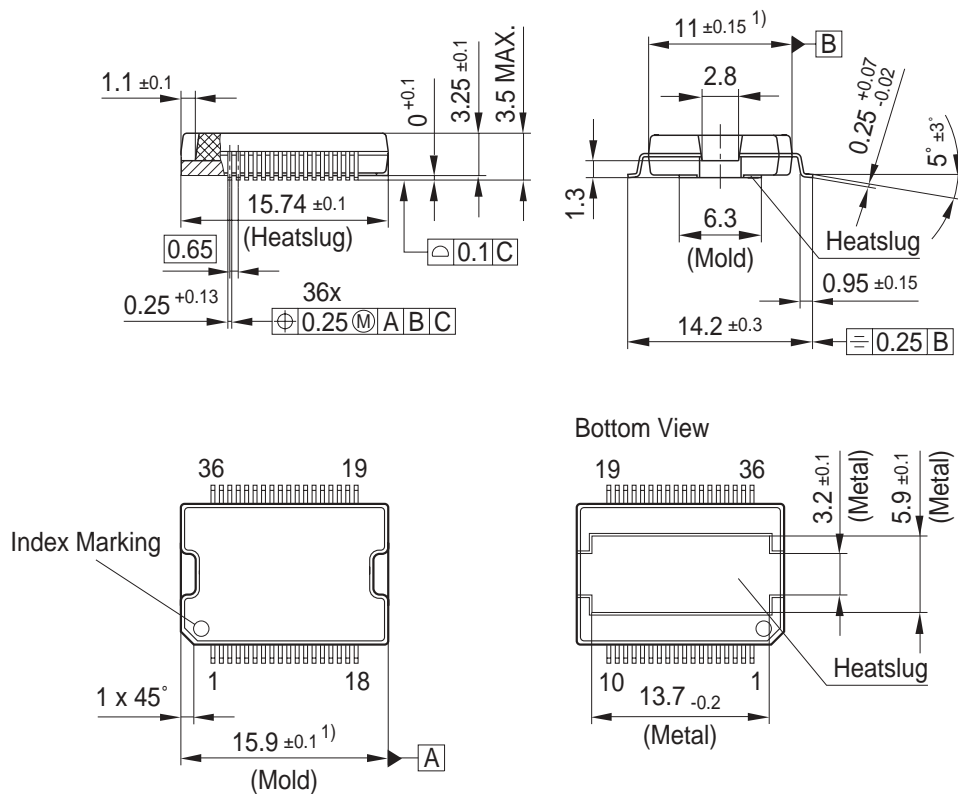

<sup>1)</sup> Does not include plastic or metal protrusion of 0.15 max. per side

see also: <http://www.infineon.com> -> Products -> Packages





**Edition 2004-09**

**Published by Infineon Technologies AG,  
St.-Martin-Strasse 53,  
81669 München, Germany**

**© Infineon Technologies AG 2/28/05.  
All Rights Reserved.**

**Attention please!**

The information herein is given to describe certain components and shall not be considered as a guarantee of characteristics.

Terms of delivery and rights to technical change reserved.

We hereby disclaim any and all warranties, including but not limited to warranties of non-infringement, regarding circuits, descriptions and charts stated herein.

**Information**

For further information on technology, delivery terms and conditions and prices please contact your nearest Infineon Technologies Office ([www.infineon.com](http://www.infineon.com)).

**Warnings**

Due to technical requirements components may contain dangerous substances. For information on the types in question please contact your nearest Infineon Technologies Office.

Infineon Technologies Components may only be used in life-support devices or systems with the express written approval of Infineon Technologies, if a failure of such components can reasonably be expected to cause the failure of that life-support device or system, or to affect the safety or effectiveness of that device or system. Life support devices or systems are intended to be implanted in the human body, or to support and/or maintain and sustain and/or protect human life. If they fail, it is reasonable to assume that the health of the user or other persons may be endangered.